

User's Manual

EPIA-NL

Version 1.12
January 30, 2012

Copyright

Copyright © 2010-2012 VIA Technologies Incorporated. All rights reserved.

No part of this document may be reproduced, transmitted, transcribed, stored in a retrieval system, or translated into any language, in any form or by any means, electronic, mechanical, magnetic, optical, chemical, manual or otherwise without the prior written permission of VIA Technologies, Incorporated.

Trademarks

All trademarks are the property of their respective holders. PS/2 is a registered trademark of IBM Corporation. AwardBIOS is a registered trademark of Phoenix Technologies Limited.

Disclaimer

No license is granted, implied or otherwise, under any patent or patent rights of VIA Technologies. VIA Technologies makes no warranties, implied or otherwise, in regard to this document and to the products described in this document. The information provided in this document is believed to be accurate and reliable as of the publication date of this document. However, VIA Technologies assumes no responsibility for the use or misuse of the information in this document and for any patent infringements that may arise from the use of this document. The information and product specifications within this document are subject to change at any time, without notice and without obligation to notify any person of such change.

FCC-B Radio Frequency Interference Statement

This equipment has been tested and found to comply with the limits for a class B digital device, pursuant to part 15 of the FCC rules. These limits are designed to provide reasonable protection against harmful interference when the equipment is operated in a commercial environment. This equipment generates, uses and can radiate radio frequency energy and, if not installed and used in accordance with the instruction manual, may cause harmful interference to radio communications. Operation of this equipment in a residential area is likely to cause harmful interference, in which case the user will be required to correct the interference at his personal expense.

Notice 1

The changes or modifications not expressly approved by the party responsible for compliance could void the user's authority to operate the equipment.

Notice 2

Shielded interface cables and A.C. power cord, if any, must be used in order to comply with the emission limits.



Tested To Comply
With FCC Standards
FOR HOME OR OFFICE USE

Safety Instructions

1. Always read the safety instructions carefully.
2. Keep this User's Manual for future reference.
3. Keep this equipment away from humidity.
4. Lay this equipment on a reliable flat surface before setting it up.
5. The openings on the enclosure are for air convection hence protects the equipment from overheating. **DO NOT COVER THE OPENINGS.**
6. Make sure the voltage of the power source and adjust properly 110/220V before connecting the equipment to the power inlet.
7. Place the power cord in such a way that people cannot step on it. Do not place anything over the power cord.
8. Always unplug the power cord before inserting any add-on card or module.
9. All cautions and warnings on the equipment should be noted.
10. Never pour any liquid into the opening. Liquid can cause damage or electrical shock.
11. If any of the following situations arises, get the equipment checked by a service personnel:
 - The power cord or plug is damaged
 - Liquid has penetrated into the equipment
 - The equipment has been exposed to moisture
 - The equipment has not work well or you cannot get it work according to User's Manual.
 - The equipment has dropped and damaged
 - If the equipment has obvious sign of breakage
12. **DO NOT LEAVE THIS EQUIPMENT IN AN ENVIRONMENT UNCONDITIONED, STORAGE TEMPERATURE ABOVE 60 C (140F), IT MAY DAMAGE THE EQUIPMENT.**



Caution:

Only use the appropriate battery specified for this product.

Do not reuse, recharge, or reheat an old battery.

Do not attempt to force open the battery.

Do not discard used batteries with regular trash.

Discard used batteries according to local regulations.



Box CONTENTS

- ❑ One VIA Nano-ITX mainboard
- ❑ One Quick Installation Guide
- ❑ One ATA-66/100/133 IDE ribbon cable
- ❑ One USB 2.0 4-port cable
- ❑ One PS2 cable for KB/MS
- ❑ One ATX power cable adapter
- ❑ One driver and utilities CD
- ❑ One 100/10 LAN cable
- ❑ One VGA cable

TABLE OF CONTENTS

Box Contents	i
Table of Contents	ii
Specifications	1
Mainboard Specifications	2
Mainboard Layout	4
Slots.....	5
Onboard Connectors.....	5
Onboard Jumpers.....	5
Installation	6
CPU.....	7
Memory Module Installation.....	9
Connecting the Power Supply	10
Connectors	11
Jumpers	19
Slots.....	20
BIOS Setup	21
Entering Setup.....	22
Control Keys	23
Navigating the BIOS Menus	24
Getting Help	25
Main Menu.....	26
Standard CMOS Features	28
IDE Drives	29
Advanced BIOS Features	30
Hard Disk Boot Priority	33
Advanced Chipset Features.....	34
AGP & P2P Bridge Control.....	37
CPU & PCI Bus Control	38
TV Output Connector.....	39
Integrated Peripherals.....	40
Super IO Device.....	42
Power Management Setup	43
Peripheral Activities.....	45
IRQs Activities	48

PNP/PCI Configurations	49
IRQ Resources	51
PC Health Status	52
Frequency/Voltage Control	53
Load Fail-Safe Defaults.....	56
Load Optimized Defaults.....	57
Set Supervisor/User Password.....	58
Save & Exit Setup	59
Exit Without Saving.....	60
Driver Installation	61
Driver Utilities.....	62
CD Content.....	64
Smart 5.1	65
Enabling Smart 5.1.....	66

This page left intentionally blank.

CHAPTER 1

Specifications

The ultra-compact and highly integrated VIA EPIA-NL Nano-ITX mainboard is the smallest form-factor available today. Through a high level of integration, the Nano-ITX measures at only 50% of the size of a Mini-ITX mainboard. The mainboard comes with an embedded VIA Luke CoreFusion™ Processor that boasts of ultra-low power consumption, space-saving package.

MAINBOARD SPECIFICATIONS

CPU

- VIA Luke CoreFusion™ Processor

South Bridge

- VIA VT8237R-series South Bridge

Graphics

- Integrated UniChrome™ Pro AGP
- MPEG-2 decoding

Audio

- VIA VT1617A 6-channel AC'97 codec

Memory

- 1 x DDR 266/333/400 SODIMM socket (up to 1 GB)

Expansion Slot

- 1 x Mini-PCI slot

IDE

- 1 x 40-pin UltraDMA 66/100/133 pin header
- 1 x 44-pin UltraDMA 66/100/133 for secondary 2.0 mm pin header

Serial ATA

- 1 x S-ATA connector

LAN

- VIA VT6103L 10/100 Base-T Ethernet PHY

TV-Out

- VIA VT1625 HDTV Encoder

Onboard I/O Connectors

- 1 x USB pin header for 8 additional USB 2.0/1.1 ports
- 1 x SIO pin header (including COM port, SIR and LPC support)
- 1 x KB/MS pin header (switchable for KB/MS connector)
- 2 x Fan connectors (CPU Fan and System Fan)
- 1 x LVDS / DVI connector (an add-on card is required)
- 1 x Audio pin header for Line-out, Line-in, Mic-in, CD-in and S/PDIF out
- 1 x TV Out pin header for S-Video, Composite and Component (YPbPr/Scart/D-Terminal)
- 1 x LAN pin header for 10/100 Ethernet LAN port
- 1 x CRT pin header (including VGA port, SMBUS and CAP0)
- 1 x Front Panel pin header
- 1 +12V Nano-ITX power connector

BIOS

- AwardBIOS with 4/8Mbit flash memory

Form Factor

- Nano-ITX (8 layers)
- 12 cm X 12 cm

MAINBOARD LAYOUT

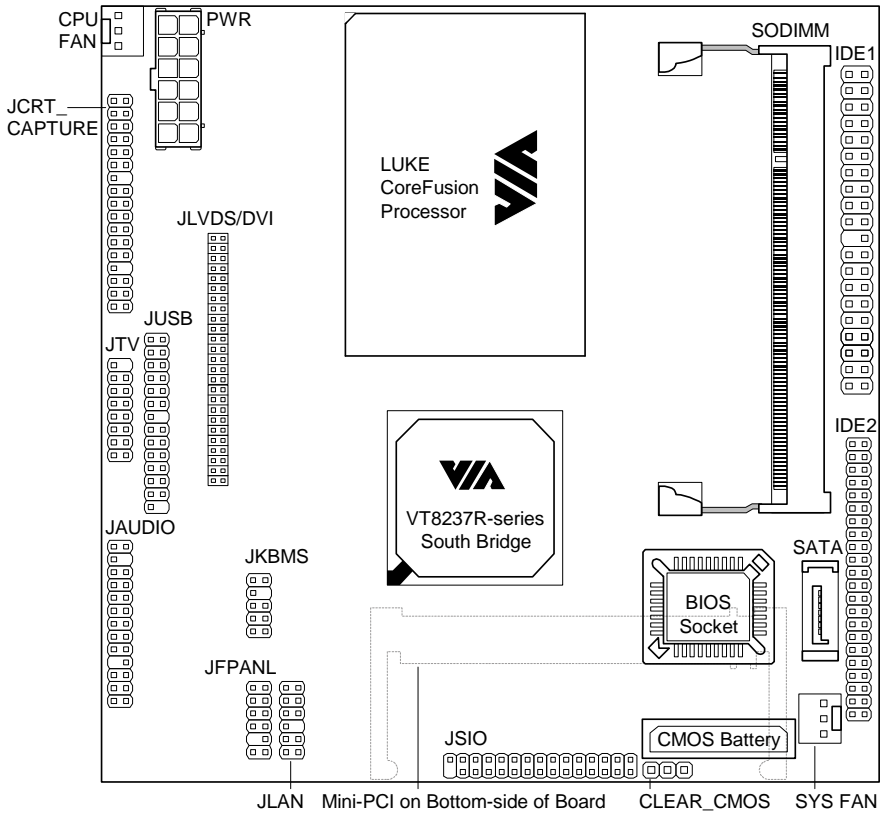

SLOTS

Port	Description	Page
Mini PCI	Expansion card slot	20
SODIMM	Memory module slot	9

ONBOARD CONNECTORS

Connector	Description	Page
Audio	Audio Jacks connector (Line-In, Line-Out, Microphone) / CD-In / SPDIF	12
CPU FAN	CPU fan connector	8
CRT	VGA port / SMBUS / CAPO connector	13
F_PANEL	Case connectors	14
IDE 1-2	IDE drive connectors	11
KB/MS	Keyboard or mouse connector	15
LAN	LAN connector	18
LVDS / DVI	LVDS or DVI connector	17
NanoITXPWR	Power cable connector	10
S-ATA	Serial ATA drive connector	16
System FAN	System fan connector	8
SIO	COM1 / LPC / SIR connector	16
USB	Universal Serial Bus connector	15
TV	TV output connector	18

ONBOARD JUMPERS

Jumper	Description	Page
CLEAR_CMOS	Reset CMOS settings	19

CHAPTER 2

Installation

This chapter provides you with information about hardware installation procedures. It is recommended to use a grounded wrist strap before handling computer components. Static electricity may damage some components.

CPU

The VIA EPIA-NL Nano-ITX mainboard includes an embedded VIA Luke CoreFusion™ Processor. The VIA Luke CoreFusion™ Processor provides ultra-low power consumption and advanced thermal dissipation properties and features a fanless design. The VIA Luke CoreFusion™ Processor requires only a heatsink to provide sufficient cooling.

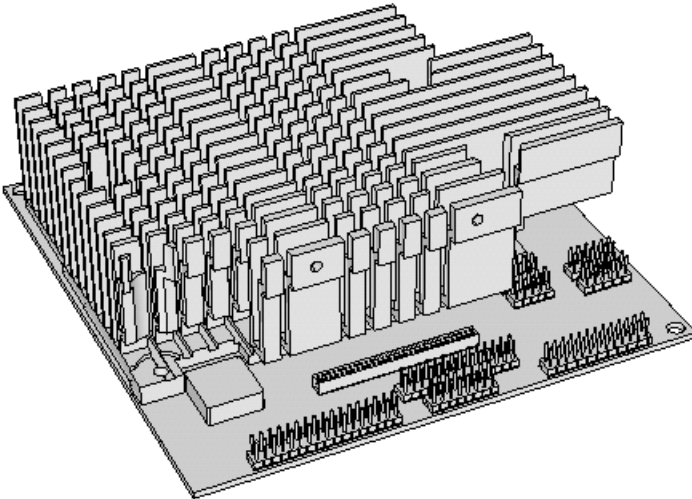

CPU Fan and System Fan: CPUFAN and SYSFAN

The CPUFAN (CPU fan) and SYSFAN (system fan) run on +12V and maintain system cooling. When connecting the wire to the connectors, always be aware that the red wire is the Positive and should be connected to the +12V. The black wire is Ground and should always be connected to GND.

FAN_MCM is a switch that is used by high-quality fans to monitor the system temperature and will automatically adjust according to the environment.

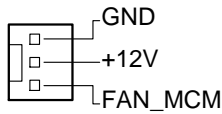

MEMORY MODULE INSTALLATION

The VIA EPIA-NL Nano-ITX mainboard provides one 200-pin SODIMM slot for DDR266/333/400 SDRAM memory modules.

DDR SDRAM Module Installation Procedures

- Make sure the notch is on the proper side.
- Insert the memory module into the slot at a 30 degree angle (30 degrees from the board). It should lightly snap into place.
- Push the module up against the board and release your finger when the clips lock the module.

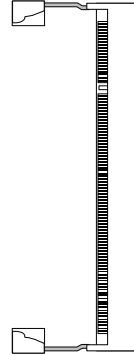

Available DDR SDRAM Configurations

Refer to the table below for available DDR SDRAM configurations on the mainboard.

Slot	Module Size	Total
SODIMM	64MB, 128MB, 256MB, 512MB, 1GB	64MB-1GB
Maximum supported system memory		64MB-1GB

CONNECTING THE POWER SUPPLY

The VIA EPIA-NL Nano-ITX mainboard requires a special power cable adapter to connect to a conventional ATX power supply. Before inserting the power supply connector, always make sure that all components are installed correctly to ensure that no damage will be caused.

Nano-ITX 12-Pin Power Connector

To connect the ATX power supply, make sure the power cable pins are properly aligned. Then insert the plug firmly into the connector.

Pin	Signal
1	+3.3V
2	+3.3V
3	+3.3V
4	+5VSUS
5	GND
6	+12V
7	-PSON
8	+5V
9	GND
10	+5V
11	GND
12	PWRGD

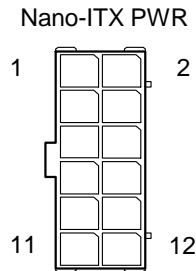

CONNECTORS

Hard Disk Connectors: IDE1 & IDE2

The mainboard has a 32-bit Enhanced IDE and Ultra DMA 66/100/133 controller that provides PIO mode 0~4, Bus Master, and Ultra DMA 66/100/133 functions. Up to four IDE devices can be connected to the system.

The primary hard drive should always be connected to IDE1 as the master drive. Both IDE drives can connect to a master and a slave drive.

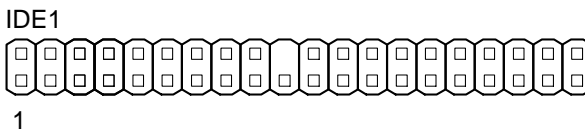

If two drives are connected to a single cable, the jumper on the second drive must be set to slave mode. Refer to the drive documentation supplied by the vendor for the jumper settings.

The mainboard has include IDE2 as 44-pin IDE connector for installing a mini 2.5 inches 44-pin IDE hard drive.

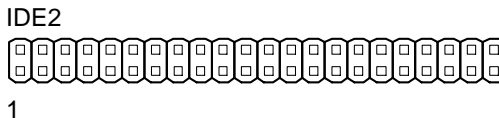

Audio Jacks Connector: JAUDIO

This pin header is for the CDRom, SPDIF and Audio connector. The Line-Out jack signals are for connecting to external speakers or headphones. The Line-In jack signals are for connecting to an external audio device such as a CD player, tape player, etc. The Mic jack signals are for connecting to a microphone. See Appendix A for details on using the 6-channel audio mode.

Pin	Signal	Pin	Signal
1	SPDIF	2	+5V
3	GND	4	Key
5	CENTER_OUTP	6	LFE_OUTP
7	SR_CH_R	8	SR_CH_L
9	LINEOUT_R	10	LINEOUT_L
11	AGND	12	AGND
13	LINEOUT_R	14	LINEOUT_L
15	LINEIN_R	16	LINEIN_L
17	MICIN2	18	MICIN1
19	Key	20	FRNMIC
21	AGND	22	AGND
23	CDR	24	CDL
25	CD_GND	26	CD_GND

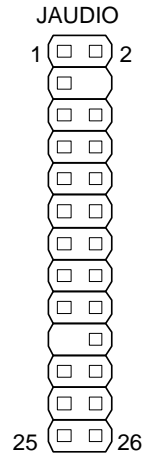

CRT Connector: JCRT_CAPTURE

This pin header can be used to attach additional port for VGA monitor, SMBUS and CAP0.

Pin	Signal	Pin	Signal
1	GND	2	+5V
3	AR_IN	4	DDC_DA
5	AG_IN	6	DDC_CK
7	AB_IN	8	HSYNC_IN
9	GND	10	VSYNC_IN
11	GND	12	GND
13	GND	14	Key
15	CPA1D1	16	CAP1CLK
17	CPA1D3	18	CPA1D0
19	CPA1D4	20	CPA1D2
21	CPA1D5	22	GND
23	CPA1D6	24	GND
25	CPA1D7	26	GND
27	GND	28	GND
29	NC	30	Key
31	SMBDT	32	SMBCK
33	GND	34	+3.3V

JCRT_CAPTURE

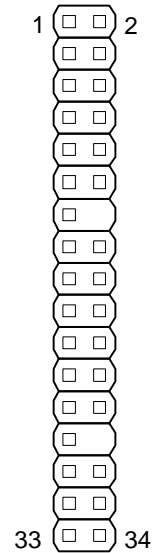

Case Connectors: FPNL

The F_PANEL pin header block allows you to connect to the power switch, reset switch, power LED, HDD LED and the case speaker.

Pin	Signal
1	+5V Dual
3	+5V Dual
5	-PLED
7	+5V
9	Key
11	SPEAKER

Pin	Signal
2	+5V
4	HD_LED
6	PW_BN
8	GND
10	Reset_SW
12	GND

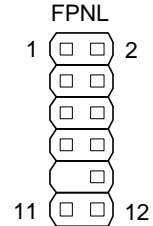

Power Switch (PW_BN)

Connect to a 2-pin push button switch. Pressing this button will turn the system power on or off.

Reset Switch (RESET)

The reset switch is used to reboot the system rather than turning the power ON/OFF. Avoid rebooting while the HDD is working. Connect the reset switch from the system case to this pin.

Power LED (PWR LED)

The LED is lit when the system is on. If the system is in S1 (POS - Power On Suspend) or S3 (STR - Suspend To RAM) state, the LED will blink.

HDD LED

HDD LED shows the activity of a hard disk drive. Avoid turning the power off while HDD LED is lit. Connect the HDD LED from the system case to this pin.

Speaker

The speaker from the system case is connected to this pin.

KBMS Connector: JKBMS

The mainboard provides a PS2 header to attach a PS2 keyboard and mouse.

Pin	Signal
1	+5V Dual
3	NC
5	GND
7	Keyboard_DATA
9	Keyboard_CLK

Pin	Signal
2	+5V Dual
4	Key
6	GND
8	Mouse_DATA
10	Mouse_CLK

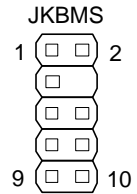

USB Connector: JUSB

This pin header is used to connect up to 8-port USB2.0/1.1 cable.

Pin	Signal
1	-OC0
3	USBDT0+
5	USBDT0-
7	GND
9	USBDT1-
11	USBDT1+
13	GND
15	-OC4
17	USBDT4+
19	USBDT4-
21	GND
23	USBDT5-
25	USBDT5+
27	GND

Pin	Signal
2	-OC2
4	USBDT2+
6	USBDT2-
8	GND
10	USBDT3-
12	USBDT3+
14	Key
16	-OC6
18	USBDT6+
20	USBDT6-
22	GND
24	USBDT7-
26	USBDT7+
28	Key

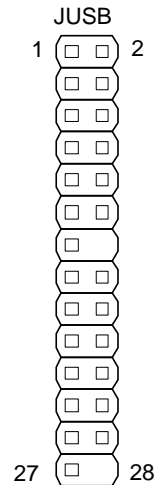

LPC / SIR Connector: JSIO

This pin header is for LPC / SIR / COM1 devices.

Pin	Signal	Pin	Signal
1	LAD1	2	LPCCLK1
3	-PCIRSTX	4	GND
5	LAD0	6	SIO_OSC
7	LAD2	8	-LFRAME
9	SERIRQ	10	LAD3
11	-LDRQ1	12	-EXTSMI
13	+5V	14	+3.3V
15	+5V	16	+3.3V
17	IRTX	18	IRRX
19	GND	20	GND
21	DCD1	22	-SIN1
23	-SOUT1	24	DTR1
25	RTS1	26	DSR1
27	-XRI1	28	CTS1
29	GND	30	Key

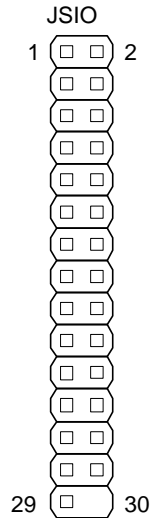

Serial ATA Connector: S-ATA

This connector is for S-ATA devices.

Pin	Signal
1	GND
2	S-ATA Port1 Transmit Positive
3	S-ATA Port1 Transmit Negative
4	GND
5	S-ATA Port1 Receive Negative
6	S-ATA Port1 Receive Positive
7	GND

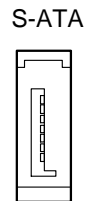

LVDS / DVI Connector: JLVDSD/DVI

This connector works as the interface to multiple display devices. An additional daughter card is required for LVDS or DVI supports respectively. The LVDS daughter card, LVDS-07, is currently available.

Pin	Signal	Pin	Signal
1	+12V	2	+5V
3	+12V	4	+5V
5	GND	6	GND
7	+3.3V	8	GND
9	ENPVVEE	10	GND
11	ENBLT	12	ENPVDD
13	FPD13	14	FPDE
15	GND	16	FPD17
17	FPD23	18	GND
19	FPVS	20	FPHS
21	FPD2	22	+5V
23	FPD11	24	FPD21
25	FPD7	26	FPD10
27	+3.3V	28	FPD20
29	+3.3V	30	Key
31	FPD9	32	FPDCLK
33	Key	34	-FPDCLK
35	FPD12	36	GND
37	FPD15	38	GND
39	FPD14	40	GND
41	FPD16	42	GND
43	FPD18	44	FPD22
45	FPD19	46	FPD1
47	FPD0	48	FPD3
49	GND	50	FPD4
51	GND	52	FPD6
53	FPD8	54	FPD5
55	GND	56	GND
57	SMB_DA	58	SMB_CK
59	-RESET_CHIP	60	GND

JLVDSD/DVI

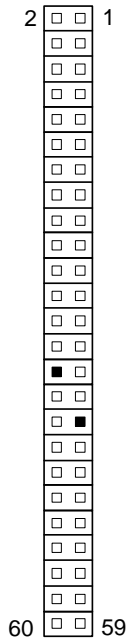

LAN Connector: JLAN

This pin header allows you to connect a network card with the LAN function.

Pin	Signal
1	+3.3VLANPH
3	P4/P5
5	RX+
7	RX-
9	P7/P8
11	GND

Pin	Signal
2	-LAN_SP100
4	TX+
6	TX-
8	Key
10	-LAN_ACT
12	GND

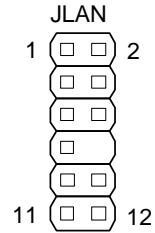

TV Out Connector: JTV

This pin header allows you to use different types of TV signal interfaces, including S-Video, RCA and Component (YPbPr / Scart / D-Terminal) outputs.

Pin	Signal
1	VDDA2
3	B_PB
5	GND
7	R_PR
9	CVBS
11	LINE1
13	LINE2
15	GND

Pin	Signal
2	Key
4	G_Y
6	GND
8	CHROMA
10	LUMA
12	GND
14	LINE3
16	GND

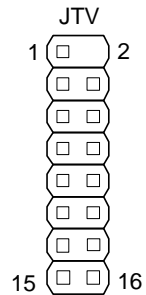



JUMPERS

The mainboard provides jumpers for setting some mainboard functions. This section will explain how to change the settings of the mainboard functions using the jumpers.

Clear CMOS: CLEAR_CMOS

The onboard CMOS RAM stores system configuration data and has an onboard battery power supply. To reset the CMOS settings, set the jumper on pins 1 and 2 while the system is off. Return the jumper to pins 2 and 3 afterwards. Setting the jumper while the system is on will damage the mainboard.

Setting	1	2	3	
Clear CMOS setting	ON	ON	OFF	 Clear
Keep CMOS setting	OFF	ON	ON	
				 Keep

SLOTS

Peripheral Component Interconnect: Mini PCI

The Mini PCI slot allows you to insert Mini PCI expansion cards. When adding or removing expansion cards, first unplug the power supply. Read the documentation for the expansion card if any changes to the system are necessary.

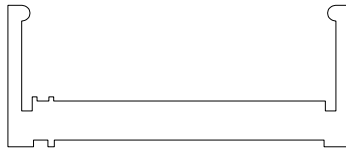

PCI Interrupt Request Routing

The IRQ (interrupt request line) are hardware lines over which devices can send interrupt signals to the microprocessor. The PCI pins are typically connected to the PCI bus as follows:

	INT B#	INT C#
Slot 1	INT C#	INT D#

CHAPTER 3

BIOS Setup

This chapter gives a detailed explanation of the BIOS setup functions.

ENTERING SETUP

Power on the computer and press <Delete> during the beginning of the boot sequence to enter the BIOS setup menu. If you missed the BIOS setup entry point, you may restart the system and try again.

CONTROL KEYS

Keys	Description
Up Arrow	Move to the previous item
Down Arrow	Move to the next item
Left Arrow	Move to the item in the left side
Right Arrow	Move to the item in the right side
Enter	Select the item
Escape	Jumps to the Exit menu or returns to the main menu from a submenu
Page Up / +	Increase the numeric value or make changes
Page Down / -	Decrease the numeric value or make changes
F1	General help, only for Status Page Setup Menu and Option Page Setup Menu
F5	Restore the previous CMOS value from CMOS, only for Option Page Setup Menu
F6	Load the default CMOS value from Fail-Safe default table, only for Option Page Setup Menu
F7	Load Optimized defaults
F9	Jumps to the Main Menu
F10	Save all the CMOS changes and exit

NAVIGATING THE BIOS MENUS

The main menu displays all the BIOS setup categories. Use the control keys Up/Down arrow keys to select any item/sub-menu. Description of the selected/highlighted category is displayed at the bottom of the screen.

An arrow symbol next to a field indicates that a sub-menu is available (see figure below). Press <Enter> to display the sub-menu. To exit the sub-menu, press <Esc>.

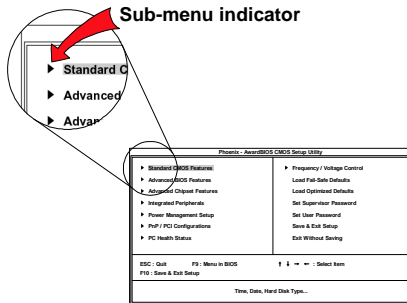

GETTING HELP

The BIOS setup program provides a "General Help" screen. You can display this screen from any menu/sub-menu by pressing <F1>. The help screen displays the keys for using and navigating the BIOS setup. Press <Esc> to exit the help screen.

MAIN MENU

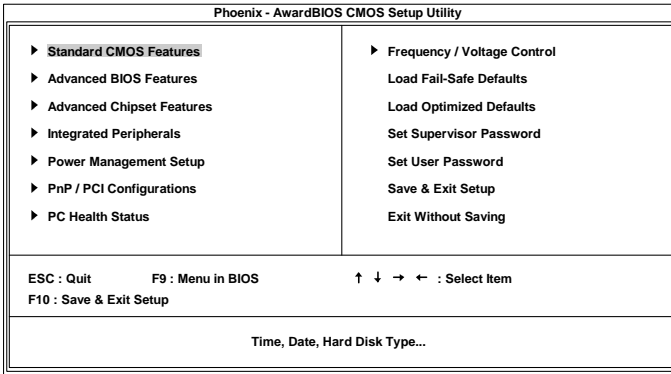

Standard CMOS Features

Use this menu to set basic system configurations.

Advanced BIOS Features

Use this menu to set the advanced features available on your system.

Advanced Chipset Features

Use this menu to set chipset specific features and optimize system performance.

Integrated Peripherals

Use this menu to set onboard peripherals features.

Power Management Setup

Use this menu to set onboard power management functions.

PnP/PCI Configurations

Use this menu to set the PnP and PCI configurations.

PC Health Status

This menu shows the PC health status.

Frequency/Voltage Control

Use this menu to set the system frequency and voltage control.

Load Fail-Safe Defaults

Use this menu option to load the BIOS default settings for minimal and stable system operations.

Load Optimized Defaults

Use this menu option to load BIOS default settings for optimal and high performance system operations.

Set Supervisor Password

Use this menu option to set the BIOS supervisor password.

Set User Password

Use this menu option to set the BIOS user password.

Save & Exit Setup

Save BIOS setting changes and exit setup.

Exit Without Saving

Discard all BIOS setting changes and exit setup.

STANDARD CMOS FEATURES

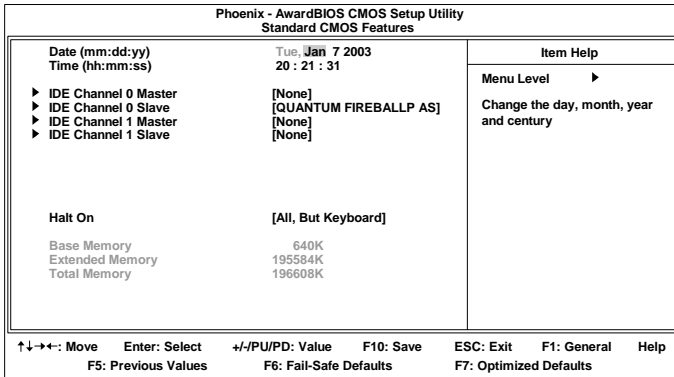

Date

The date format is [Day, Month Date Year]

Time

The time format is [Hour : Minute : Second]

Halt On

Sets the system’s response to specific boot errors. Below is a table that details the possible settings.

Setting	Description
All Errors	System halts when any error is detected
No Errors	System does not halt for any error
All, But Keyboard	System halts for all non-key errors



Note:

Channels 2 and 3 will only appear if the “S-ATA Mode” menu item in the “Integrated Peripherals” menu is set to “IDE Controller”.

IDE DRIVES

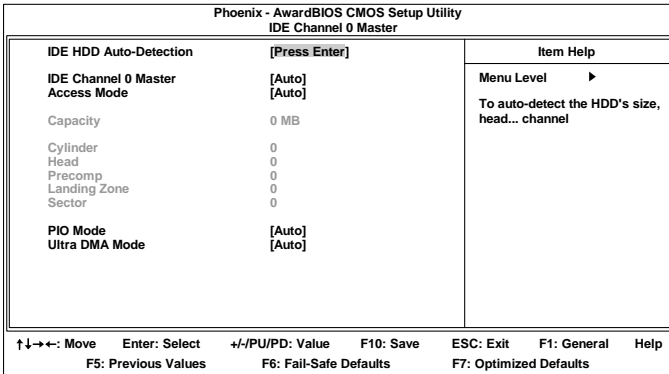

The specifications of your drive must match with the drive table. The hard disk will not work properly if you enter incorrect information in this category. Select "Auto" whenever possible. If you select "Manual", make sure the information is from your hard disk vendor or system manufacturer. Below is a table that details required hard drive information when using the "Manual" mode.

Setting	Description
IDE Channel	The name of this match the name of the menu. Settings: [None, Auto, Manual]
Access Mode	Settings: [CHS, LBA, Large, Auto]
Capacity	Formatted size of the storage device
Cylinder	Number of cylinders
Head	Number of heads
Precomp	Write precompensation
Landing Zone	Cylinder location of the landing zone
Sector	Number of sectors
PIO Mode	Settings: [0, 1, 2, 3, 4]
Ultra DMA Mode	Settings: [Disabled, Auto]

ADVANCED BIOS FEATURES

Phoenix - AwardBIOS CMOS Setup Utility Advanced BIOS Features		
▶ Hard Disk Boot Priority	[Press Enter]	Item Help
Virus Warning	[Disabled]	Menu Level ▶
CPU Internal Cache	[Enabled]	Select Hard Disk Boot Priority
Quick Power On Self Test	[Enabled]	
First Boot Device	[USB-FDD]	
Second Boot Device	[CDROM]	
Third Boot Device	[Hard Disk]	
Boot Other Device	[Enabled]	
Boot Up NumLock Status	[On]	
Typematic Rate Setting	[Enabled]	
Typematic Rate (Chars/Sec)	[30]	
Typematic Delay (Msec)	[250]	
Security Option	[Setup]	
APIC Mode	[Enabled]	
MPS Version Control for OS	[1.4]	
Display Full Screen Logo	[Enabled]	
Display Small Logo	[Disabled]	

↑↓→←: Move	Enter: Select	+/-/PU/PD: Value	F10: Save	ESC: Exit	F1: General	Help
F5: Previous Values	F6: Fail-Safe Defaults	F7: Optimized Defaults				

Virus Warning

When set to “Enabled”, virus protection is enabled for the hard disk boot sector.

Settings: [Enabled, Disabled]

CPU Internal Cache

When set to “Enabled”, turns on processor internal cache.

Settings: [Enabled, Disabled]

Quick Power On Self-Test

Shortens Power On Self-Test (POST) cycle to enable shorter boot up time.

When set to “Enabled”, some of the device checking tests are skipped during the POST.

Settings: [Enabled, Disabled]

First/Second/Third Boot Device

Set the boot device sequence as BIOS attempts to load the disk operating system.

Setting	Description
LS120	Boot from LS-120 drive
Hard Disk	Boot from the HDD
CD-ROM	Boot from CD-ROM
ZIP100	Boot from ATAPI ZIP drive
USB-FDD	Boot from USB floppy drive
USB-ZIP	Boot from USB ZIP drive
USB-CDROM	Boot from USB CDROM
Legacy LAN	Boot from network drive
Disabled	Disable the boot device sequence

Boot Other Device

Enables the system to boot from alternate devices if the system fails to boot from the "First/Second/Third Boot Device" list. When set to "Disabled", no alternate boot devices are allowed.

Settings: [Enabled, Disabled]

Boot Up NumLock Status

Set the NumLock status when the system is powered on. When set to "On", the keypad behaves as 10-key. When set to "Off", the keypad behaves as arrow keys.

Settings: [On, Off]

Typematic Rate Setting

Enables "Typematic Rate" and "Typematic Delay" functions.

Settings: [Enabled, Disabled]

Typematic Rate (Chars/Sec)

This item sets the rate (characters/second) at which the system retrieves a signal from a depressed key.

Settings: [6, 8, 10, 12, 15, 20, 24, 30]

Typematic Delay (Msec)

This item sets the delay between when the key was first pressed and when the system begins to repeat the signal from the depressed key.

Settings: [250, 500, 750, 1000]

Security Option

Selects whether the password is required every time the System boots, or only when you enter Setup. When set to "Setup", a password prompt appears when BIOS Setup is launched. When set to "System", a password prompt appears whenever the system is powered on as well as when the BIOS Setup is launched.

Settings: [Setup, System]

APIC Mode

Settings: [Enabled, Disabled]

MPS Variation Control for OS

Settings: [1.1, 1.4]

Display Full Screen Logo

Show full screen logo during BIOS boot up process.

Settings: [Enabled, Disabled]

Display Small Logo

Show small energy star logo during BIOS boot up process.

Settings: [Enabled, Disabled]

HARD DISK BOOT PRIORITY

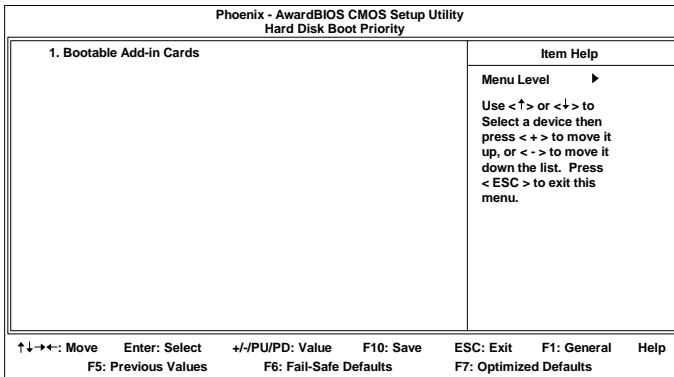

This is for setting the priority of the hard disk boot order when the "Hard Disk" option is selected in the "[First/Second/Third] Boot Device" menu item.

ADVANCED CHIPSET FEATURES

Phoenix - AwardBIOS CMOS Setup Utility Advanced Chipset Features		
		Item Help
Display Card Priority	[PCI Slot]	
▶ AGP & P2P Bridge Control	[Press Enter]	
▶ CPU & PCI Bus Control	[Press Enter]	
Select Display Device	[CRT]	Menu Level ▶
Panel Type	[1024x768 : 1 :On]	
HDTV Display	Disabled	
HDTV Type	HDTV 720P	
HDTV Input Mode	RGB Input	
TV H/W Layout	[Default]	If there are display cards on both AGP and PCI slots, configure this item for BIOS to select which one to boot
TV Type	[NTSC]	
▶ TV Output Connector	[Press Enter]	

↑↓→←: Move Enter: Select +/-/PU/PD: Value F10: Save ESC: Exit F1: General Help
 F5: Previous Values F6: Fail-Safe Defaults F7: Optimized Defaults



Caution:
 The Advanced Chipset Features menu is used for optimizing the chipset functions. Do not change these settings unless you are familiar with the chipset.

Display Card Priority

This setting specifies which VGA card is your primary graphics adapter.
 Settings: [PCI Slot and AGP]

Select Display Device

This setting refers to the type of display being used with the system.
 Settings: [CRT, LCD, CRT + LCD, TV, CRT + TV, LCD + TV, DVI, CRT + DVI, TV + DVI]

Panel Type

This setting refers to the native resolution of the display being used with the system. (i.e.: Resolution : Channel : Dithering)
 Settings: [640x480:1:On, 800x600:1:On, 1024x768:1:On, 1280x768:1:On, 1280x1024:2:On, 1400x1050:2:On, 1600x1200:2:On, 1280x800:1:On,

800x480:1:On, 1024x768:2:On, 1024x768:1:Off, 1280x768:2:Off,
1280x768:1:Off, 1280x1024:2:Off, 1400x1050:2:Off, 1600x1200:2:Off]

TV H/W Layout

Settings: [Default, COMPOSITE + S-Video, COMP. + R/G/B, COMP. + Y/Cb/Cr, COMP. + SDTV-R.G.B, COMP. + SDTV-Y.Pb.Pr, COMPOSITE, S-Video, R.G.B, Y.Cb.Cr, SDTV – R.G.B, SDTV – Y.Pb.Pr, S-Video + R.G.B, S-Video + Y.b.Cr]

TV Type

This setting refers to the native resolution of the display being used with the system.

Settings: [NTSC, PAL]

AGP & P2P BRIDGE CONTROL

Phoenix - AwardBIOS CMOS Setup Utility		Item Help
AGP & P2P Bridge Control		
AGP Aperture Size	[128]	
AGP 3.0 Mode	8x	
VGA Share Memory Size	[64]	Menu Level ▶
Direct Frame Buffer Size	[Enabled]	

↑↓→←: Move Enter: Select +/-/PU/PD: Value F10: Save ESC: Exit F1: General Help
 F5: Previous Values F6: Fail-Safe Defaults F7: Optimized Defaults

AGP Aperture Size

This setting controls how much memory space can be allocated to AGP for video purposes. The aperture is a portion of the PCI memory address range dedicated to graphics memory address space. Host cycles that hit the aperture range are forwarded to the AGP without any translation.

Settings: [32MB, 64MB, 128MB, 256MB, 512MB, 1G]

AGP 3.0 Mode

This mainboard supports the AGP 8x interface. When the AGP 8x video card is used, it can transfer video data at 2.1GB/s. AGP 8x is backward compatible, leave the default 8x mode on. AGP 8x mode can be detected automatically once you plug in the AGP 8x card.

Settings: [8x, 4x, 2x, 1x]

VGA Share Memory Size

Settings: [Disabled, 16M, 32M, 64M]

Direct Frame Buffer

Settings: [Enabled, Disabled]

CPU & PCI BUS CONTROL

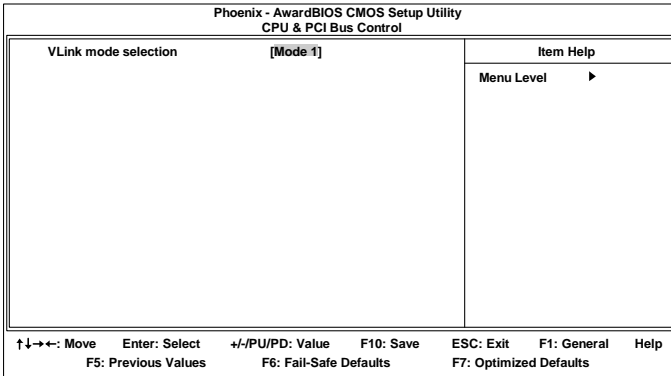

V-Link mode selection

This menu item controls the data transfer speed between the north and south bridge.

Settings: [By Auto, Mode 0~4]

TV OUTPUT CONNECTOR

Phoenix - AwardBIOS CMOS Setup Utility		
TV Output Connector		
CVBS (Composite)	[Enabled]	Item Help
S-Video 0 (Y/C)	[Enabled]	
R/G/B	[Disabled]	Menu Level ▶
Cr/Y/Cb	[Disabled]	
SDTV-R/G/B	[Disabled]	
SDTV-Pr/Y/Pb	[Disabled]	

↑↓→←: Move	Enter: Select	+-/PU/PD: Value	F10: Save	ESC: Exit	F1: General	Help
	F5: Previous Values	F6: Fail-Safe Defaults		F7: Optimized Defaults		

INTEGRATED PERIPHERALS

Phoenix - AwardBIOS CMOS Setup Utility		
Integrated Peripherals		
SuperIO Device	[Press Enter]	Item Help
Onboard IDE Channel 1	[Enabled]	Menu Level ▶
Onboard IDE Channel 2	[Enabled]	
IDE Prefetch Mode	[Enabled]	
OnChip SATA	[Enabled]	
SATA Mode	[RAID]	
AC97 Audio	[Auto]	
VIA OnChip LAN	[Enabled]	
Onboard LAN Boot ROM	[Disabled]	
OnChip USB Controller	[All Enabled]	
OnChip EHCI Controller	[Enabled]	
USB Emulation	[On]	

↑↓→←: Move Enter: Select +/-/PU/PD: Value F10: Save ESC: Exit F1: General Help
 F5: Previous Values F6: Fail-Safe Defaults F7: Optimized Defaults

Onboard IDE Channel 1 and 2

The integrated peripheral controller contains an IDE interface with support for two IDE channels. When set to “Enabled”, each channel is activated separately.

Settings: [Enabled, Disabled]

IDE Prefetch Mode

This allows the hard disk controller to use the fast block mode to transfer data to and from the hard disk drive. Block mode is also called block transfer, multiple commands or multiple sector read/write. When set to “Enabled”, block mode is enabled.

Settings: [Enabled, Disabled]

OnChip S-ATA

Settings: [Enabled, Disabled]

S-ATA Mode

Serial ATA is the latest generation of the ATA interface. Serial ATA hard drives deliver transfer speeds of up to 150MB/sec.

Settings: [IDE, RAID]

AC'97 Audio

Auto allows the mainboard to detect whether an audio device is used. If the device is detected, the onboard VIA AC'97 (Audio Codec'97) controller will be enabled; otherwise, it is disabled. Disable the controller if another controller card is being used to connect to an audio device. When set to "Auto", the onboard controller is enabled if an audio device is detected.

Settings: [Auto, Disabled]

VIA OnChip LAN

Settings: [Enabled, Disabled]

Onboard LAN Boot ROM

When set to "Enabled", decide whether to invoke the boot ROM of the onboard LAN chip.

Settings: [Enabled, Disabled]

OnChip USB Controller

Settings: [All Enabled, All Disabled]

OnChip EHCI Controller

Settings: [Enabled, Disabled]

USB Emulation

Set this field to choose the USB emulation. When set to "OFF ", do not support any USB device on DOS. When set to "KB/MS", support USB legacy keyboard and mouse, no support USB storage. And set to "ON", support USB legacy keyboard, mouse and storage.

Settings: [OFF, KB/MS, ON]

SUPER IO DEVICE

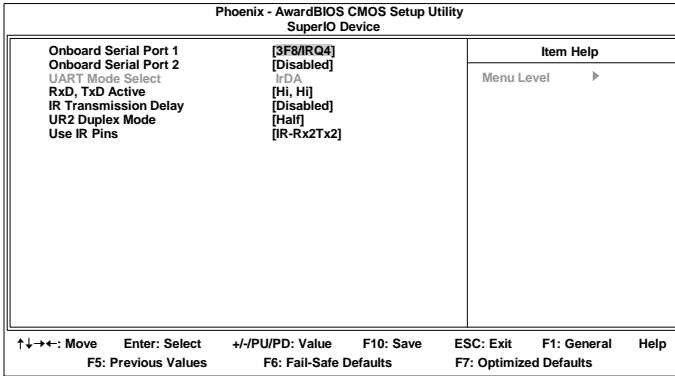

Onboard Serial Port 1 and 2

Sets the base I/O port address and IRQ for the onboard serial ports A and B. Selecting "Auto" allows the BIOS to automatically determine the correct base I/O port address.

Port	Settings					
1	Disabled	3F8	2F8	3E8	2E8	Auto
		IRQ4	IRQ3	IRQ4	IRQ3	
2	Disabled	3F8	2F8	3E8	2E8	Auto
		IRQ4	IRQ3	IRQ4	IRQ3	

UART Mode Select

Settings: [rDA]

RxD, TxD Active

Settings: [Hi,Hi, Hi.Lo, Lo.Hi, Lo.Lo]

IR Transmission Delay

Settings: [Disabled, Enabled]

UR2 Duplex Mode

Settings: [Full, Half]

Use IR Pins

Settings: [RxD2.TxD2, IR-Rx2Tx2]

POWER MANAGEMENT SETUP

Phoenix - AwardBIOS CMOS Setup Utility Power Management Setup		
ACPI Suspend Type	[S1(POS)]	Item Help
HDD Power Down	[Disable]	Menu Level ▶
Power Management Timer	[Disable]	This item allows you to select how the BIOS put the system in power saving mode.
Video Off Option	[Suspend -> Off]	S1(POS): System in low power mode
Power Off by PWRBTN	[Instant-Off]	S3(STR): All components are powered off except memory.
Run VGABIOS if S3 Resume	[Auto]	S1 & S3: Depends on OS to select S1 or S3
AC Loss Auto restart	[Off]	
▶ Peripherals Activities	[Press Enter]	
▶ IRQs Activities	[Press Enter]	

↑↓←→: Move Enter: Select +/-/PU/PD: Value F10: Save ESC: Exit F1: General Help
 F5: Previous Values F6: Fail-Safe Defaults F7: Optimized Defaults

ACPI Suspend Type

Setting	Description
S1(POS)	S1/Power On Suspend (POS) is a low power state. In this state, no system context (CPU or chipset) is lost and hardware maintains all system contexts.
S3(STR)	S3/Suspend To RAM (STR) is a power-down state. In this state, power is supplied only to essential components such as main memory and wakeup-capable devices. The system context is saved to main memory, and context is restored from the memory when a "wakeup" event occurs.
S1 & S3	Depends on the OS to select S1 or S3.

HDD Power Down

Sets the length of time for a period of inactivity before powering down the hard disk.

Settings: [Disabled, 1~15(minutes)]

Power Management Timer

Set the idle time before system enters power saving mode. ACPI OS such as Windows XP will override this option.

Settings: [Disabled, 1/2/4/6/8/10/20/30/40(minutes), 1(hour)]

Video Off Option

Select whether or not to turn off the screen when system enters power saving mode, ACPI OS such as Windows XP will override this option.

Setting	Description
Always On	Screen is always on even when system enters power saving mode
Suspend -> Off	Screen is turned off when system enters power saving mode

Power Off by PWRBTN

This field configures the power button on the chassis.

Setting	Description
Delay 4 Sec	System is turned off if power button is pressed for more than four seconds
Instant-Off	Power button functions as a normal power-on/-off button

Run VGABIOS if S3 Resume

Select whether to run VGA BIOS if resuming from S3 state. This is only necessary for older VGA drivers.

Settings: [Auto, Yes, No]

AC Loss Auto restart

The field defines how the system will respond after an AC power loss during system operation.

Setting	Description
Off	Keeps the system in an off state until the power button is pressed
On	Restarts the system when the power is back
Former-Sts	Restores the system to its previous state

PERIPHERAL ACTIVITIES

Phoenix - AwardBIOS CMOS Setup Utility		
Peripherals Activities		
VGA Event	[OFF]	Item Help
COM Event	[COM]	Menu Level ▶
HDD Event	[ON]	
PCI Master Event	[OFF]	
PS2KB Wakeup Select	[Hot Key]	
PS2MS Wakeup from S3/S4/S5	[Disabled]	
PS2KB Wakeup from S3/S4/S5	[Disabled]	
USB Resume	[Disabled]	
PowerOn by PCI Card	[Disabled]	
Modem Ring Resume	[Disabled]	
RTC Alarm Resume	[Disabled]	
Date (of Month)	0	
Resume Time (hh:mm:ss)	0: 0: 0	
↑↓→←: Move Enter: Select +/-/PU/PD: Value F10: Save ESC: Exit F1: General Help F5: Previous Values F6: Fail-Safe Defaults F7: Optimized Defaults		

VGA Event

Enables the power management unit to monitor VGA activities.

Settings: [Off, On]

COM Event

Decide whether or not the power management unit should monitor parallel port (LPT) and serial port (COM) activities.

Settings: [None, COM]

HDD Event

Enables the power management unit to monitor hard disk and floppy drive activities.

Settings: [Off, On]

PCI Master Event

Enables the power management unit to monitor PCI master activities.

Settings: [Off, On]

PS2KB Wakeup Select

When selecting "Password", press <Page Up> or <Page Down> to change password. The maximum number of characters is eight. "PS2MS Wakeup from S3/S4/S5" and "PS2KB Wakeup from S3/S4/S5" will be disabled while changing the password.

Settings: [Hot Key, Password]

PS2MS Wakeup from S3/S4/S5

Enables any mouse activity to restore the system from the power saving mode to an active state.

Settings: [Disabled, Enabled]

PS2KB Wakeup from S3/S4/S5

Sets a Hot Key to restore the system from the power saving mode to an active state.

Settings: [Disabled, Ctrl+F1, Ctrl+F2, Ctrl+F3, Ctrl+F4, Ctrl+F5, Ctrl+F6, Ctrl+F7, Ctrl+F8, Ctrl+F9, Ctrl+F10, Ctrl+F11, Ctrl+F12, Power, Wake, Any Key]

USB Resume

Enables activity detected from USB devices to restore the system from a suspended state to an active state.

Settings: [Disabled, Enabled]

PowerOn by PCI Card

Enables activity detected from any PCI card to power up the system or resume from a suspended state. Such PCI cards include LAN card, onboard LAN controller, onboard USB ports, etc.

Settings: [Disabled, Enabled]

Modem Ring Resume

Enables any Wake-on LAN or Ring-In signals from the Ethernet or modem to restore the system from a suspended state to an active state.

Settings: [Disabled, Enabled]

RTC Alarm Resume

Sets a scheduled time and/or date to automatically power on the system.

Settings: [Disabled, Enabled]

Date (of Month)

The field specifies the date for "RTC Alarm Resume".

Resume Time (hh:mm:ss)

The field specifies the time for "RTC Alarm Resume".

IRQs ACTIVITIES

Phoenix - AwardBIOS CMOS Setup Utility		
IRQs Activities		
		Item Help
Primary INTR	[ON]	
IRQ3 (Reserved)	[Disabled]	
IRQ4 (COM 1)	[Enabled]	
IRQ5 (Reserved)	[Disabled]	
IRQ6 (Floppy Disk)	[Enabled]	
IRQ7 (Reserved)	[Disabled]	
IRQ8 (RTC Alarm)	[Disabled]	
IRQ9 (IRQ2 Redir)	[Disabled]	
IRQ10 (Reserved)	[Disabled]	
IRQ11 (Reserved)	[Disabled]	
IRQ12 (PS/2 Mouse)	[Enabled]	
IRQ13 (Coprocesor)	[Enabled]	
IRQ14 (Hard Disk)	[Enabled]	
IRQ15 (Reserved)	[Disabled]	
		Menu Level ▶ If you choose Disabled, the power management unit will not monitor any IRQ activities.

↑↓→←: Move Enter: Select +/-/PU/PD: Value F10: Save ESC: Exit F1: General Help
 F5: Previous Values F6: Fail-Safe Defaults F7: Optimized Defaults

Primary INTR

Restores the system to an active state if IRQ activity is detected from any of the enabled channels

Settings: [Off, On]

IRQ3~IRQ15

Enables or disables the monitoring of the specified IRQ line. These fields are only available if "Primary INTR" is on.

Settings: [Enabled, Disabled]



Note:

IRQ (Interrupt Request) lines are system resources allocated to I/O devices. When an I/O device needs to gain attention of the operating system, it signals this by causing an IRQ to occur. After receiving the signal, when the operating system is ready, the system will interrupt itself and perform the service required by the IO device.

PNP/PCI CONFIGURATIONS

Phoenix - AwardBIOS CMOS Setup Utility		
PnP / PCI Configurations		
		Item Help
PNP OS Installed	[No]	Menu Level ▶ Select Yes if you are using a Plug and Play capable operating system. Select No if you need the BIOS to configure non-boot devices.
Reset Configuration Data	[Disabled]	
Resources Controlled by	[Auto(ESCD)]	
IRQ Resources	Press Enter	
Assign IRQ for VGA	[Enabled]	
Assign IRQ for USB	[Enabled]	
↑↓→←: Move Enter: Select +/-/PU/PD: Value F10: Save ESC: Exit F1: General Help F5: Previous Values F6: Fail-Safe Defaults F7: Optimized Defaults		



Note:
 This section covers some very technical items and it is strongly recommended to leave the default settings as is unless you are an experienced user.

PNP OS Installed

When set to “Yes”, the BIOS will only initialize the PnP cards used for booting (VGA, IDE, SCSI). The rest of the cards will be initialized by the PnP operating system. When set to “No”, the BIOS will initialize all the PnP cards.

Settings: [Yes, No]

Reset Configuration Data

This field should usually be left “Disabled”. When set to “Enabled”, the ESCD (Extended System Configuration Data) is reset after exiting BIOS Setup only when a newly installed PCI card or the system configuration prevents the operating system from loading.

Settings: [Enabled, Disabled]

Resource Controlled By

Enables the BIOS to automatically configure all the Plug-and-Play compatible devices. When set to "Auto(ESCD)", the BIOS will automatically assign IRQ, DMA and memory base address fields. When set to "Manual", all of the "IRQ Resources" become available for manual configuration.

Settings: [Auto(ESCD), Manual]

Assign IRQ For VGA/USB

Assign IRQ for VGA and USB devices.

Settings: [Disabled, Enabled]

IRQ RESOURCES

Phoenix - AwardBIOS CMOS Setup Utility		
IRQ Resources		
IRQ-3 assigned to	[PCI Device]	Item Help
IRQ-4 assigned to	[PCI Device]	
IRQ-5 assigned to	[PCI Device]	Menu Level ▶
IRQ-7 assigned to	[PCI Device]	
IRQ-9 assigned to	[PCI Device]	
IRQ-10 assigned to	[PCI Device]	Legacy ISA for devices
IRQ-11 assigned to	[PCI Device]	compliant with the original PC
IRQ-12 assigned to	[PCI Device]	AT bus specification, PCI / ISA
IRQ-14 assigned to	[PCI Device]	PnP for devices compliant
IRQ-15 assigned to	[PCI Device]	with the Plug and Play
		standard whether designed
		for PCI or ISA bus architecture

↑↓→←: Move Enter: Select +/-/PU/PD: Value F10: Save ESC: Exit F1: General Help
 F5: Previous Values F6: Fail-Safe Defaults F7: Optimized Defaults



Note:
 The items are adjustable only when “Resources Controlled By” is set to “Manual”.

IRQ Resources list IRQ 3/4/5/7/9/10/11/12/14/15 for users to set each IRQ a type depending on the type of device using the IRQ.

Setting	Description
PCI Device	For Plug-and-Play compatible devices designed for PCI bus architecture
Reserved	The IRQ will be reserved for other requests

PC HEALTH STATUS

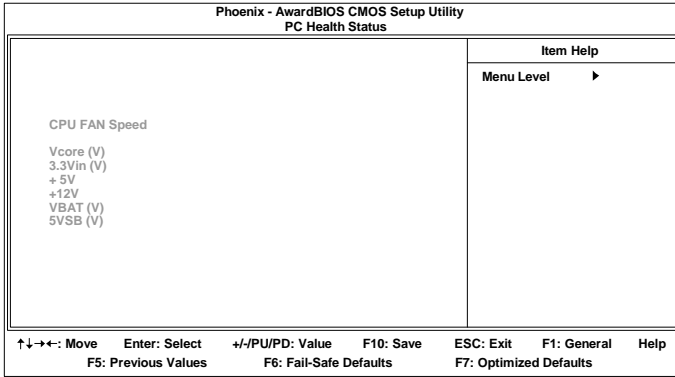

The PC Health Status displays the current status of all of the monitored hardware devices/components such as CPU voltages and fan speeds.

FREQUENCY/VOLTAGE CONTROL

Phoenix - AwardBIOS CMOS Setup Utility Frequency / Voltage Control		
DRAM Clock	[By SPD]	Item Help
DRAM Timing	[Auto By SPD]	Menu Level ▶
SDRAM CAS Latency	2.5	
Bank Interleave	Disabled	
Precharge to Active(Trp)	4T	
Active to Precharge(Tras)	9T	
Active to CMD(Trcd)	4T	
REF to ACT/REF to REF(Trfc)	15T	
ACT(0) to ACT(1) (TRRD)	3T	
DRAM Command Rate	[2T Command]	
Spread Spectrum Range	+/- 0.3%	
Spread Spectrum	[Enabled]	

↑↓→←: Move Enter: Select +/-/PU/PD: Value F10: Save ESC: Exit F1: General Help
 F5: Previous Values F6: Fail-Safe Defaults F7: Optimized Defaults

DRAM Clock

The chipset supports synchronous and asynchronous mode between host clock and DRAM clock frequency.

Settings: [By SPD, 100 MHz, 133 MHz, 166 MHz, 200MHz]

DRAM Timing

The value in this field depends on the memory modules installed in your system. Changing the value from the factory setting is not recommended unless you install new memory that has a different performance rating than the original modules.

Settings: [Manual, Auto By SPD]

SDRAM CAS Latency

This item is for setting the speed it takes for the memory module to complete a command. Generally, a lower setting will improve the performance of your system. However, if your system becomes less stable, you should change it to a higher setting. This field is only available when "DRAM Timing" is set to "Manual".

Settings: [1.5, 2, 2.5, 3]

Bank Interleave

This item is for setting the interleave mode of the SDRAM interface. Interleaving allows banks of SDRAM to alternate their refresh and access cycles. One bank will undergo its refresh cycle while another is being accessed. This improves performance of the SDRAM by masking the refresh time of each bank. This field is only available when "DRAM Timing" is set to "Manual".

Settings: [Disabled, 2 Bank, 4 Bank]

Precharge to Active (Trp)

This field is for setting the length of time it takes to precharge a row in the memory module before the row becomes active. Longer values are safer but may not offer the best performance. This field is only available when "DRAM Timing" is set to "Manual".

Settings: [2T, 3T, 4T, 5T]

Active to Precharge (Tras)

This field is for setting the length of time it a row stays active before precharging. Longer values are safer but may not offer the best performance. This field is only available when "DRAM Timing" is set to "Manual".

Settings: [6T, 7T, 8T, 9T]

Active to CMD (Trcd)

This field is only available when "DRAM Timing" is set to "Manual".

Settings: [2T, 3T, 4T, 5T]

REF to ACT / REF to REF (Trfc)

This field is only available when "DRAM Timing" is set to "Manual".

Settings: [12T, 13T, 14T, 15T]

ACT(0) to ACT(1) (TRRD)

This field is only available when "DRAM Timing" is set to "Manual".

Settings: [2T, 3T]

DRAM Command Rate

This field is for setting how fast the memory controller sends out commands. Lower setting equals faster command rate.

**Note:**

Some memory modules may not be able to handle lower settings.

Settings: [2T Command, 1T Command]

Spread Spectrum Range

Settings: [+/-0.1%, +/-0.2%, +/-0.3%, +/-0.6%]

Spread Spectrum

When the mainboard's clock generator pulses, the extreme values (spikes) of the pulses creates EMI (Electromagnetic Interference). The Spread Spectrum function reduces the EMI generated by modulating the pulses so that the spikes of the pulses are reduced to flatter curves.

Settings: [Disabled, Enabled]

LOAD FAIL-SAFE DEFAULTS

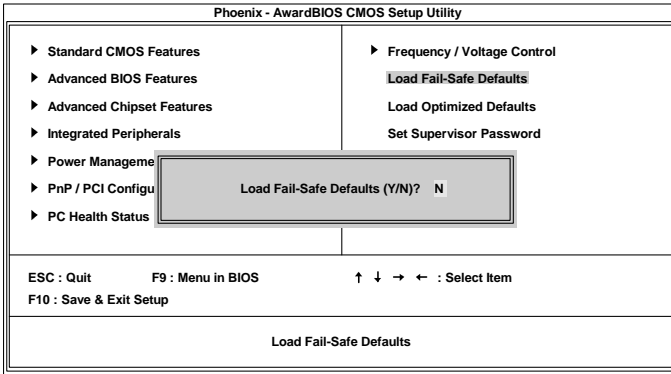

This option is for restoring all the default fail-safe BIOS settings. These values are set by the mainboard manufacturer to provide a stable system with basic performance.

Entering "Y" loads the default fail-safe BIOS values.

LOAD OPTIMIZED DEFAULTS

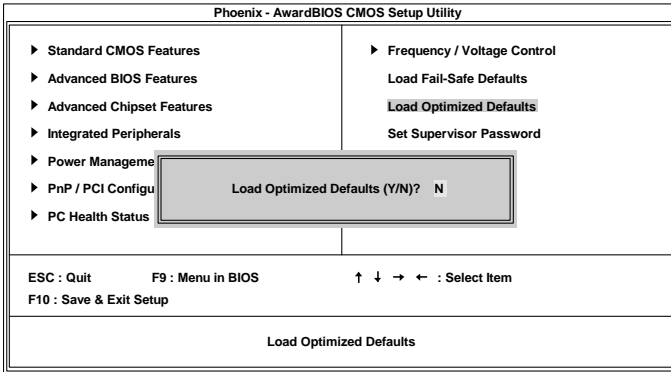

This option is for restoring all the default optimized BIOS settings. The default optimized values are set by the mainboard manufacturer to provide a stable system with optimized performance.

Entering "Y" loads the default optimized BIOS values.

SET SUPERVISOR/USER PASSWORD

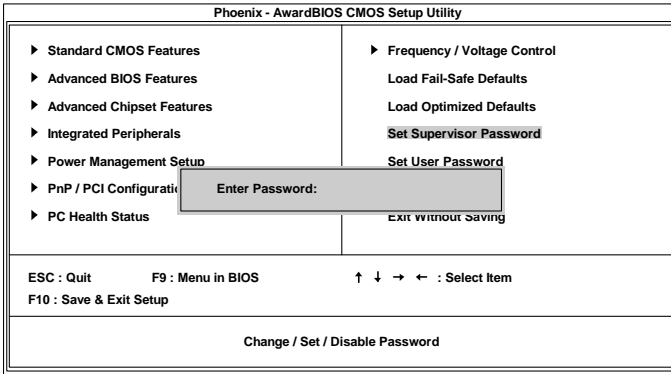

This option is for setting a password for entering BIOS Setup. When a password has been set, a password prompt will be displayed whenever BIOS Setup is run. This prevents an unauthorized person from changing any part of your system configuration.

There are two types of passwords you can set. A supervisor password and a user password. When a supervisor password is used, the BIOS Setup program can be accessed and the BIOS settings can be changed. When a user password is used, the BIOS Setup program can be accessed but the BIOS settings cannot be changed.

To set the password, type the password (up to eight characters in length) and press <Enter>. The password typed now will clear any previously set password from CMOS memory. The new password will need to be reentered to be confirmed. To cancel the process press <Esc>.

To disable the password, press <Enter> when prompted to enter a new password. A message will show up to confirm disabling the password. To cancel the process press <Esc>.

Additionally, when a password is enabled, the BIOS can be set to request the password each time the system is booted. This would prevent unauthorized use of the system. See "Security Option" in the "Advanced BIOS Features" section for more details.

SAVE & EXIT SETUP

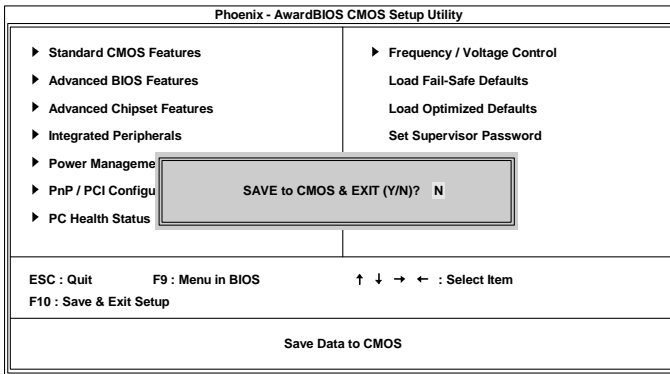

Entering "Y" saves any changes made and exits the program.

Entering "N" will cancel the exit request.

EXIT WITHOUT SAVING

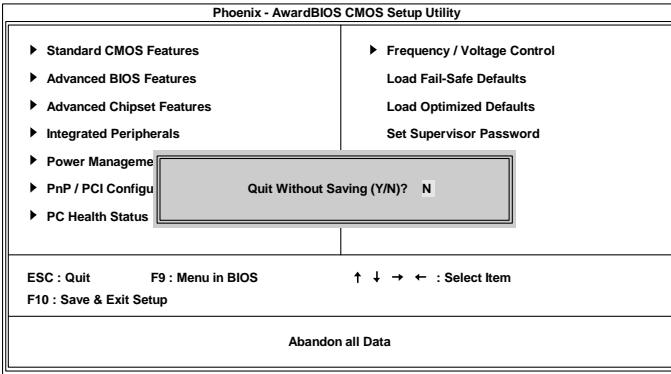

Entering "Y" discards any changes made and exits the program.

Entering "N" will cancel the exit request.

CHAPTER 4

Driver Installation

This chapter gives you brief descriptions of each mainboard driver and application. You must install the VIA chipset drivers first before installing other drivers such as audio or VGA drivers. The applications will only function correctly if the necessary drivers are already installed.

DRIVER UTILITIES

Getting Started

The mainboard includes a Driver Utilities CD that contains the driver utilities and software for enhancing the performance of the mainboard. If the CD is missing from the retail box, please contact the local dealer for the CD.



Note:

The driver utilities and software are updated from time to time. The latest updated versions are available at <http://www.viaembedded.com>.

Running the Driver Utilities CD

To start using the CD, insert the CD into the CD-ROM or DVD-ROM drive. The CD should run automatically after closing the CD-ROM or DVD-ROM drive. The driver utilities and software menu screen should then appear on the screen. If the CD does not run automatically, click on the "Start" button and select "Run..." Then type: "D:\Setup.exe".

**Note:**

D: might not be the drive letter of the CD-ROM/DVD-ROM in your system.

CD CONTENT

- ❑ **VIA 4in1 Drivers:** Contains VIA ATAPI Vendor Support Driver (enables the performance enhancing bus mastering functions on ATA-capable Hard Disk Drives and ensures IDE device compatibility), AGP VxD Driver (provides service routines to your VGA driver and interface directly to hardware, providing fast graphical access), IRQ Routing Miniport Driver (sets the system's PCI IRQ routing sequence) and VIA INF Driver (enables the VIA Power Management function).
- ❑ **VIA Graphics Driver:** Enhances the onboard VIA graphic chip.
- ❑ **VIA Audio Driver:** Enhances the onboard VIA audio chip.
- ❑ **VIA USB 2.0 Driver:** Enhances VIA USB 2.0 ports.
- ❑ **VIA LAN Driver:** Enhances the onboard VIA LAN chip.
- ❑ **VIA S-ATA Driver**

APPENDIX A

Smart 5.1

This chapter gives you brief description of how Smart 5.1 is enabled if your board is equipped with the VT1617A 6-channel AC'97 codec.

ENABLING SMART 5.1

Smart5.1 allows the system to output 6-channel audio directly from the audio jacks on the mainboard, using the traditional line-in, line-out and microphone jacks as output jacks. Windows® XP/2000 supports 6-channel. Windows® 98 only supports 4-channel. The examples in this section are based on Windows® XP.



Note:

Your media entertainment software needs to support 6-channels in order for you to experience Smart5.1. Consult the user manual that came with your software for more information.

Example A

1. Double-click "Sounds and Audio Devices" icon in the control panel.

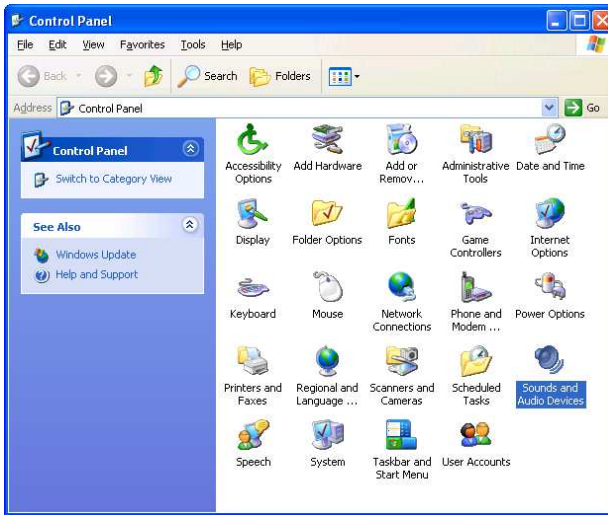

2. Select the "Audio" tab. Then press "Advanced" as shown in the picture.

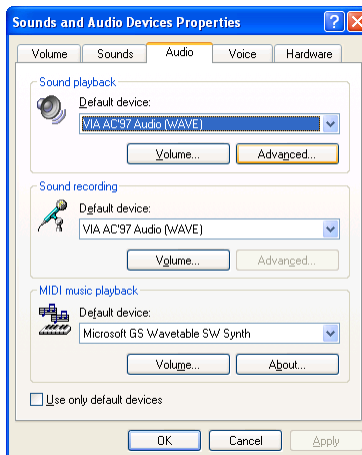

3. Choose "5.1 surround sound speakers" to support the 6-channel function.



Example B

1. Double-click "Sounds and Audio Devices" icon in the control panel and then select the "Audio" tab on the panel as shown below. Press the "Volume" button in the "Sound playback" area

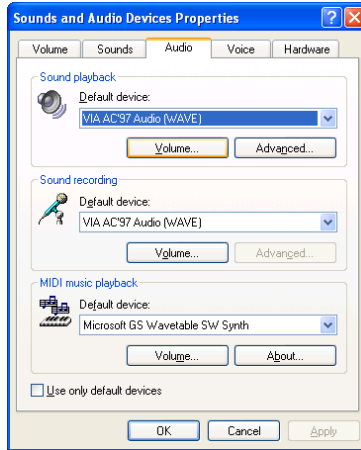

2. Select "Options" from the "Front Speaker" panel and select the item "Advanced Controls".

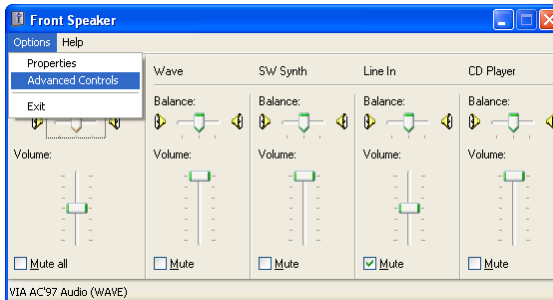

3. Click on the “Advanced” button.

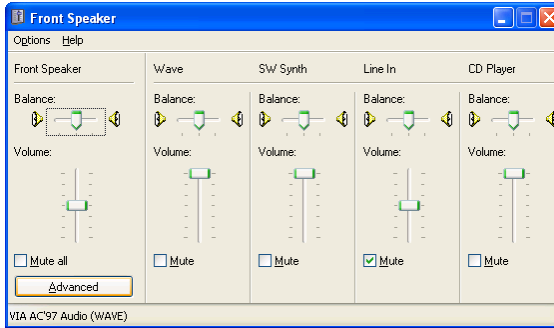

4. Check the “Smart5.1 Enable” item as shown in the panel below.

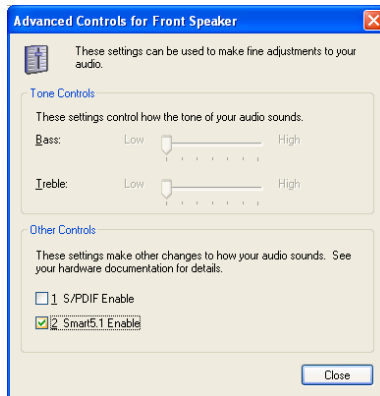

After completing the previous settings, connect the speakers to the 3-jack connectors.

Shown below are the corresponding connections to setup the 6-channel system.

Jack	2-channel	6-channel
Line-out	Line-out	Front (Left/Right)
Line-in	Line-in	Rear (Left/Right)
Microphone	Microphone	Center/Sub-woofer