

User's Manual

EPIA-PX

Version 1.25
May 28, 2018

Copyright

Copyright © 2006-2012 VIA Technologies Incorporated. All rights reserved.

No part of this document may be reproduced, transmitted, transcribed, stored in a retrieval system, or translated into any language, in any form or by any means, electronic, mechanical, magnetic, optical, chemical, manual or otherwise without the prior written permission of VIA Technologies, Incorporated.

Trademarks

All trademarks are the property of their respective holders. PS/2 is a registered trademark of IBM Corporation. Award BIOS is a registered trademark of Phoenix Technologies Ltd.

Disclaimer

No license is granted, implied or otherwise, under any patent or patent rights of VIA Technologies. VIA Technologies makes no warranties, implied or otherwise, in regard to this document and to the products described in this document. The information provided in this document is believed to be accurate and reliable as of the publication date of this document. However, VIA Technologies assumes no responsibility for the use or misuse of the information in this document and for any patent infringements that may arise from the use of this document. The information and product specifications within this document are subject to change at any time, without notice and without obligation to notify any person of such change.

FCC-B Radio Frequency Interference Statement

This equipment has been tested and found to comply with the limits for a class B digital device, pursuant to part 15 of the FCC rules. These limits are designed to provide reasonable protection against harmful interference when the equipment is operated in a commercial environment. This equipment generates, uses and can radiate radio frequency energy and, if not installed and used in accordance with the instruction manual, may cause harmful interference to radio communications. Operation of this equipment in a residential area is likely to cause harmful interference, in which case the user will be required to correct the interference at his personal expense.

Notice 1

The changes or modifications not expressly approved by the party responsible for compliance could void the user's authority to operate the equipment.

Notice 2

Shielded interface cables and A.C. power cord, if any, must be used in order to comply with the emission limits.



Tested To Comply
With FCC Standards
FOR HOME OR OFFICE USE

KC Korean Certificate Statement



KCC-REM-VNT-EPIA-PX (B)

VIA Technologies, Inc.

EPIA-PX

Global Brands MFR LTD PCBA Business Unit

2007/04

Made in China

B 급 기기
(가정용 방송통신기자재)

이 기기는 가정용 (B 급) 전자파적합기기로서 주
로 가정에서 사용하는 것을 목적으로 하며, 모
든 지역에서 사용할 수 있습니다.

Class B Equipment
(For Home Use
Broadcasting & Communication
Equipment)

This electromagnetic wave equipment is suitable
for home use (Class B) and may be used mainly
at home and in other areas.

Safety Instructions

1. Always read the safety instructions carefully.
2. Keep this User's Manual for future reference.
3. Keep this equipment away from humidity.
4. Lay this equipment on a reliable flat surface before setting it up.
5. The openings on the enclosure are for air convection hence protects the equipment from overheating. **DO NOT COVER THE OPENINGS.**
6. Make sure the voltage of the power source and adjust properly 110/220V before connecting the equipment to the power inlet.
7. Place the power cord in such a way that people cannot step on it. Do not place anything over the power cord.
8. Always unplug the power cord before inserting any add-on card or module.
9. All cautions and warnings on the equipment should be noted.
10. Never pour any liquid into the opening. Liquid can cause damage or electrical shock.
11. If any of the following situations arises, get the equipment checked by a service personnel:
 - The power cord or plug is damaged
 - Liquid has penetrated into the equipment
 - The equipment has been exposed to moisture
 - The equipment has not work well or you cannot get it work according to User's Manual.
 - The equipment has dropped and damaged
 - If the equipment has obvious sign of breakage
12. **DO NOT LEAVE THIS EQUIPMENT IN AN ENVIRONMENT UNCONDITIONED, OR STORAGE TEMPERATURE ABOVE 60°C (140°F), THE EQUIPMENT MAY BE DAMAGED.**



Caution:

- Only use the appropriate battery specified for this product.
- Do not reuse, recharge, or reheat an old battery.
- Do not attempt to force open the battery.
- Do not discard used batteries with regular trash.
- Discard used batteries according to local regulations.



Box CONTENTS

- One EPIA PX Pico-ITX Mainboard
- One ATA-133/100/66 IDE Ribbon Cable
- One PS/2 Ribbon Cable
- One Power Ribbon Cable
- One COM Port Ribbon Cable
- One DVI Ribbon Cable
- One Driver Utility CD
- Two Screws (for the COM port)

TABLE OF CONTENTS

SPECIFICATIONS	1
MAINBOARD SPECIFICATIONS	2
MAINBOARD LAYOUT	4
BACK PANEL LAYOUT	4
INSTALLATION.....	5
CPU	6
<i>CPU Fan: CPU_FAN</i>	<i>6</i>
MEMORY MODULE INSTALLATION.....	7
<i>Memory Slot: DDR2_SODIMM.....</i>	<i>7</i>
<i>Available DDR2 SDRAM Configurations</i>	<i>7</i>
CONNECTING THE POWER SUPPLY	8
<i>Pico-ITX 12-Pin Power Connector</i>	<i>8</i>
BACK PANEL PORTS	9
<i>VGA Port.....</i>	<i>9</i>
<i>RJ45 LAN Port.....</i>	<i>9</i>
CONNECTORS	10
<i>IDE Connector: IDE</i>	<i>10</i>
<i>Serial ATA Connectors: SATA</i>	<i>11</i>
<i>USB Pin Connector: USB</i>	<i>11</i>
<i>KBMS Connector: PS/2</i>	<i>11</i>
<i>Case Connector: Front Panel.....</i>	<i>12</i>
<i>Power Switch (PW_BN).....</i>	<i>12</i>
<i>Reset Switch (RST_SW)</i>	<i>12</i>
<i>Power LED (PWR_LED)</i>	<i>12</i>
<i>HDD LED (HD_LED).....</i>	<i>12</i>
<i>Speaker (SPEAK).....</i>	<i>12</i>
<i>Audio Connector: AUDIO</i>	<i>13</i>
<i>Serial Port Connector: COM Port</i>	<i>13</i>
<i>LVDS/DVI Panel Connector: LVDS Panel.....</i>	<i>14</i>
<i>Multimedia Connector.....</i>	<i>16</i>
JUMPERS.....	17
<i>Clear CMOS: CMOS Reset</i>	<i>17</i>

BIOS SETUP	19
ENTERING SETUP.....	20
CONTROL KEYS.....	21
NAVIGATING THE BIOS MENUS	22
GETTING HELP	23
MAIN MENU.....	24
<i>Standard CMOS Features</i>	24
<i>Advanced BIOS Features</i>	24
<i>Advanced Chipset Features</i>	24
<i>Integrated Peripherals</i>	24
<i>Power Management Setup</i>	24
<i>PnP/PCI Configurations</i>	24
<i>Frequency/Voltage Control</i>	24
<i>Load Fail-Safe Defaults</i>	25
<i>Load Optimized Defaults</i>	25
<i>Set Supervisor Password</i>	25
<i>Set User Password</i>	25
<i>Save & Exit Setup</i>	25
<i>Exit Without Saving</i>	25
STANDARD CMOS FEATURES	26
<i>Date</i>	26
<i>Time</i>	26
<i>Halt On</i>	26
<i>Video</i>	26
IDE DRIVES.....	27
ADVANCED BIOS FEATURES.....	28
<i>Virus Warning</i>	28
<i>Quick Power On Self-Test</i>	28
<i>First/Second/Third Boot Device</i>	29
<i>Boot Other Device</i>	29
<i>Boot Up NumLock Status</i>	29
<i>Typematic Rate Setting</i>	29
<i>Security Option</i>	30
<i>MPS Variation Control for OS</i>	30
<i>OS Select For DRAM > 64MB</i>	30

<i>Full Screen Logo Show</i>	30
CPU FEATURE	31
<i>Deploy Prior to Thermal</i>	31
<i>Thermal Management</i>	31
<i>TM2 Bus Ratio</i>	31
<i>TM2 Bus VID</i>	32
<i>C7 CMPXCHGB</i>	32
<i>C7 NoExecute (NX)</i>	32
HARD DISK BOOT PRIORITY.....	33
ADVANCED CHIPSET FEATURES.....	34
<i>Memory Hole</i>	34
<i>System BIOS Cacheable</i>	34
<i>Video RAM Cacheable</i>	34
<i>Init Display First</i>	34
<i>Select Display Device</i>	35
<i>Panel Type</i>	35
AGP & P2P BRIDGE CONTROL.....	36
<i>AGP Aperture Size</i>	36
<i>AGP 2.0 Mode</i>	36
<i>AGP Driving Control</i>	37
<i>AGP Fast Write</i>	37
<i>AGP Master 1 WS Write</i>	37
<i>AGP Master 1 WS Read</i>	37
<i>AGP 3.0 Calibration Cycle</i>	37
<i>VGA Share Memory Size</i>	37
<i>Direct Frame Buffer</i>	37
CPU & PCI BUS CONTROL.....	38
<i>PCI Master 0 WS Write</i>	38
<i>PCI Delay Transaction</i>	38
<i>DRDY_Timing</i>	38
INTEGRATED PERIPHERALS	39
<i>Onboard Serial Port</i>	39
VIA ONCHIP PCI DEVICE	40
<i>Azalia HDA Controller</i>	40
<i>LAN Boot ROM</i>	40

USB DEVICE SETTING	41
<i>USB 1.0 Controller</i>	41
<i>USB 2.0 Controller</i>	41
<i>USB Operation Mode</i>	41
<i>USB Keyboard Function</i>	42
<i>USB Storage Function</i>	42
<i>No Device</i>	42
POWER MANAGEMENT SETUP	43
<i>ACPI Suspend Type</i>	43
<i>Power Management Option</i>	43
<i>HDD Power Down</i>	43
<i>Suspend Mode</i>	44
<i>Video Off Option</i>	44
<i>Video Off Method</i>	44
<i>MODEM Use IRQ</i>	44
<i>Soft-Off by PWRBTN</i>	44
<i>Run VGABIOS if S3 Resume</i>	44
<i>AC Loss Auto restart</i>	44
WAKEUP EVENT DETECT	45
<i>PS2KB Wakeup Select</i>	45
<i>PS2KB Wakeup Key Select</i>	45
<i>PS2MS Wakeup Key Select</i>	45
<i>PS2 Keyboard Power On</i>	46
<i>PS2 Mouse Power On</i>	46
<i>PowerOn by PCI Card</i>	46
<i>Modem Ring Resume</i>	46
<i>RTC Alarm Resume</i>	46
<i>Date (of Month)</i>	46
<i>Resume Time (hh:mm:ss)</i>	46
PNP/PCI CONFIGURATIONS	47
<i>PNP OS Installed</i>	47
<i>Reset Configuration Data</i>	47
<i>Resource Controlled By</i>	48
<i>PCI/VGA Palette Snoop</i>	48
<i>Assign IRQ For VGA/USB</i>	48

<i>Maximum ASPM supported</i>	48
<i>Maximum Payload Size</i>	48
FREQUENCY / VOLTAGE CONTROL.....	49
<i>Auto Detect PCI Clk</i>	49
DRAM CLOCK/DRIVE CONTROL	50
<i>DRAM Clock</i>	50
<i>DRAM Timing</i>	50
<i>Read to Precharge (Trtp)</i>	51
<i>Write to Read CMD (Twtr)</i>	51
<i>Write Recovery Time (Twr)</i>	51
<i>DRAM Command Rate</i>	51
<i>RDSAIT mode</i>	51
LOAD FAIL-SAFE DEFAULTS	52
LOAD OPTIMIZED DEFAULTS.....	53
SET SUPERVISOR / USER PASSWORD	54
SAVE & EXIT SETUP.....	56
EXIT WITHOUT SAVING	57
DRIVER INSTALLATION	59
DRIVER UTILITIES	60
<i>Getting Started</i>	60
<i>Running the Driver Utilities CD</i>	61
CD CONTENT	62

CHAPTER 1

Specifications

The ultra-compact and highly integrated VIA EPIA-PX Pico-ITX mainboard is the smallest form-factor available today. Through a high level of integration, the Pico-ITX measures at only 25% of the size of a Mini-ITX mainboard. The mainboard enables the creation of an exciting new generation of small, ergonomic, innovative and affordable embedded systems.

MAINBOARD SPECIFICATIONS

CPU

- Supports VIA C7 1.0GHz NanoBGA2 Processor

Chipset

- VIA VX700 Advanced All-in-One System Processor

Memory

- 1 x DDR2 533 SODIMM slot (up to 1 GB)

Graphics

- Integrated C-Pro II 3D/2D AGP with MPEG-2 and WMV9 Video Decoding Acceleration

IDE

- 1 x UltraDMA 133/100 connector (2.0mm 40-pin connector)

Serial ATA

- 1 x SATA connector

LAN

- VIA VT6106S 10/100 Mbps Fast Ethernet Controller with Power Management Functions

Audio

- VIA VT1708A High Definition Audio Codec

Back Panel I/O Port

- 1 x RJ-45 LAN Port
- 1 x VGA Port

Onboard I/O Connectors

- 1 x USB pin connector for 4 additional USB 2.0 ports
- 1 x COM pin connector
- 1 PS2 mouse/keyboard pin connector
- 1 Fan pin connector for CPU Fan
- 1 x LVDS/DVI panel pin connector
- 1 Audio pin connector for Line-in, Mic-in, S/PDIF in, and 5.1 Channels Audio Output
- 1 Multimedia connector to support External TV-Out Interface, Video Capture Port Interface and Low Pin Count Interface. (One VT1625 add-on card is required.)
- 1 x Pico-ITX power connector

BIOS

- Award BIOS with LPC 4/8Mbit flash memory capacity

Form Factor

- Pico-ITX (10 layers)
- 10 cm X 7.2 cm

MAINBOARD LAYOUT

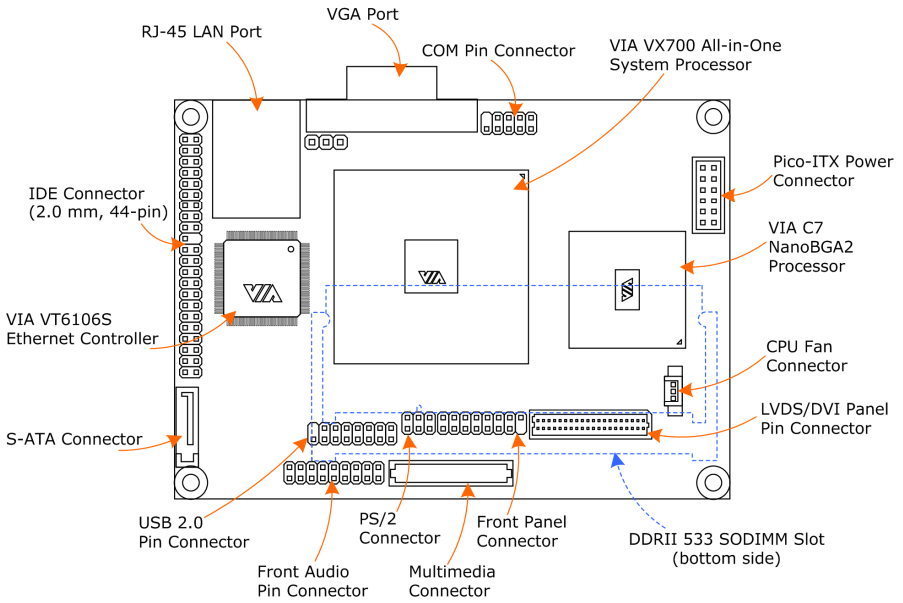

BACK PANEL LAYOUT

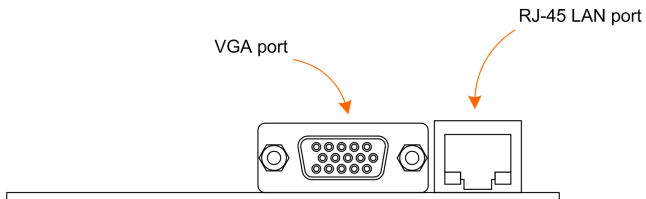

CHAPTER 2

Installation

This chapter provides you with information about hardware installation procedures. It is recommended to use a grounded wrist strap before handling computer components. Electrostatic discharge (ESD) can damage some components.

CPU

The VIA EP8057 Pico-ITX mainboard can support VIA C7 NanoBGA2 processor. The processor requires a heatsink with fan for 1.0GHz SKU.

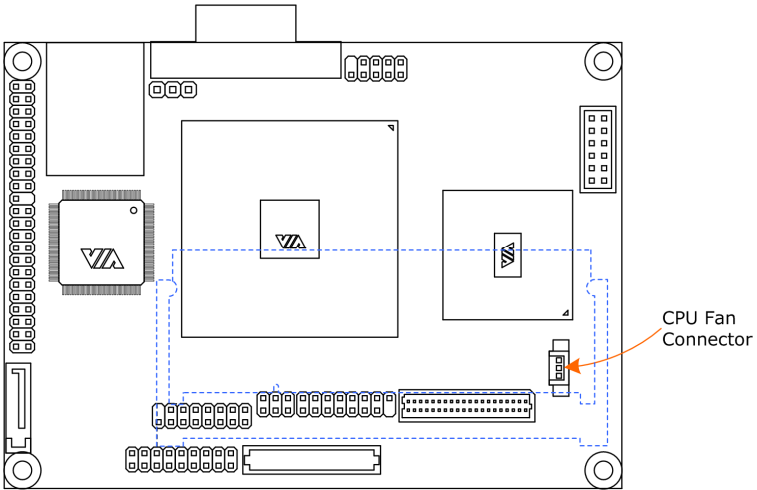

CPU Fan: CPU_FAN

The CPU_FAN runs on +5V and maintain CPU cooling. When connecting the wire to the connectors, always be aware that the red wire (positive wire) should be connected to +5V. The black wire is Ground and should always be connected to GND.

Pin	Signal
1	FAN OUT
2	+5V
3	GND



MEMORY MODULE INSTALLATION

Memory Slot: DDR2_SODIMM

The VIA EPIA-PX Pico-ITX mainboard provides one SODIMM slot for DDR2 533 SDRAM memory modules and supports memory sizes up to 1GB.

Insert the SODIMM module at a 45 degree angle.

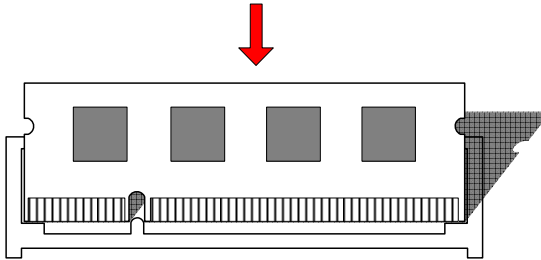

Push the SODIMM module back towards the board until the clips lock the module in place.

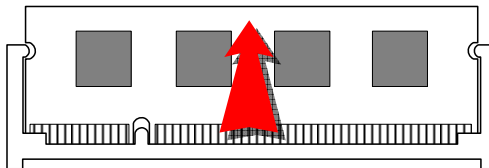

Available DDR2 SDRAM Configurations

Refer to the table below for available DDR2 SDRAM configurations on the mainboard.

Slot	Module Size	Total
SODIMM	64MB, 128MB, 256MB, 512MB, 1GB	64MB-1GB
Maximum supported system memory		64MB-1GB



Note:

Only supports 1GB SODIMM with 64M x 8bits x16 configuration.

CONNECTING THE POWER SUPPLY

The VIA EPIA-PX Pico-ITX mainboard supports a Pico-ITX power supply for the power system. Before inserting the power supply connector, always make sure that all components are installed correctly to ensure that no damage will be caused.

Pico-ITX 12-Pin Power Connector

To connect the power supply, make sure the power plug is inserted in the proper orientation and the pins are aligned. Then push down the plug firmly into the connector.

Pin	Signal
1	+3.3V
2	+5V_SB
3	+12V
4	+5V
5	+5V
6	PWRGD
7	+3.3V
8	+3.3V
9	GND
10	PWRON
11	GND
12	GND

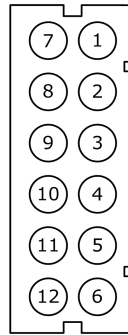

BACK PANEL PORTS

The back panel has the following layout:

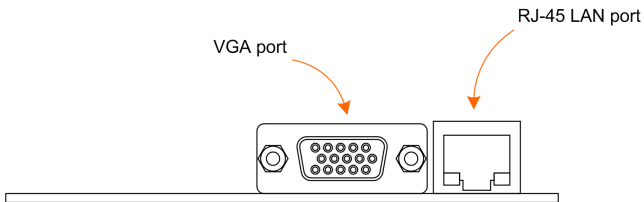

VGA Port

The 15-pin female VGA connector can be used to connect to any analog VGA monitor.

RJ45 LAN Port

The mainboard provides a standard RJ45 port for enabling connections to networks.

CONNECTORS

IDE Connector: IDE

The mainboard has an Ultra DMA 133/100 controller. You can connect up to two IDE devices in any combination.

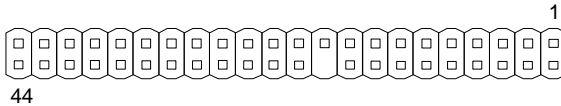

If two drives are connected to a single cable, the jumper on the second drive must be set to slave mode. Refer to the drive documentation supplied by the vendor for the jumper settings.

Pin	Signal	Pin	Signal
1	#IDERST	2	GND
3	PDD7	4	PDD8
5	PDD6	6	PDD9
7	PDD5	8	PDD10
9	PDD4	10	PDD11
11	PDD3	12	PDD12
13	PDD2	14	PDD13
15	PDD1	16	PDD14
17	PDD0	18	PDD15
19	GND	20	NC
21	PDDREQ	22	GND
23	#PDIOW	24	GND
25	#PDIOR	26	GND
27	PIORDY	28	GND
29	#PDDACK	30	GND
31	IRQ15	32	NC
33	PDA1	34	GP10
35	PDA0	36	PDA2
37	#PDCS1	38	#PDCS3
39	#HD_LED1	40	GND
41	+5V	42	+5V
43	GND	44	NC

Serial ATA Connectors: SATA

The next generation connector supports thin Serial ATA cables for primary internal storage devices. The current Serial ATA interface allows up to 150MB/s data transfer rate, faster than the standard parallel ATA with 133 MB/s (Ultra DMA).

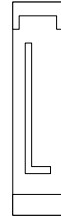

USB Pin Connector: USB

The mainboard provides 1 USB pin connector that allows up to 4 USB 2.0 ports to be added. This port can be used to connect high-speed USB interface peripherals such as USB HDD, digital cameras, MP3 players, printers, modem and the like.

Pin	Signal
1	GND
3	GND
5	+USB_VD2
7	-USB_VD2
9	+5V
11	-USB_VD1
13	+USB_VD1
15	GND

Pin	Signal
2	NC
4	GND
6	+USB_VD3
8	-USB_VD3
10	+5V
12	-USB_VD0
14	+USB_VD0
16	GND

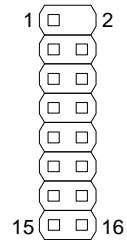

KBMS Connector: PS/2

The mainboard provides a PS2 pin header to attach a PS2 keyboard and mouse.

Pin	Signal
1	A5V
3	KBCLK
5	MSCLK

Pin	Signal
2	GND
4	KBDATA
6	MSDATA

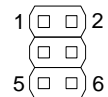

Case Connector: Front Panel

This pin header allows you to connect the power switch, reset switch, power LED, HDD LED and the case speaker.

Pin	Signal
1	PW_LED
3	PW_LED
5	-
7	+5V
9	GND
11	#EXTSMI
13	SPEAK
15	NC

Pin	Signal
2	+5V
4	HDD_LED
6	PW_BN
8	GND
10	RST_SW
12	GND
14	+5V
16	-

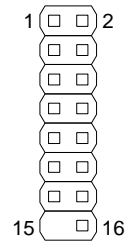

Power Switch (PW_BN)

Connect to a 2-pin power button switch. Pressing this button will turn the system power on or off.

Reset Switch (RST_SW)

The reset switch is used to reboot the system rather than turning the power ON/OFF. Avoid rebooting the system, if the HDD is still working. Connect the reset switch from the system case to this pin.

Power LED (PWR_LED)

The LED will light when the system is on. If the system is in S1 (POS - Power On Suspend) or S3 (STR - Suspend To RAM) state, the LED will blink.

HDD LED (HD_LED)

HDD LED shows the activity of a hard disk drive. Avoid turning the power off when the HDD LED still has a lit. Connect the HDD LED from the system case to this pin.

Speaker (SPEAK)

The speaker from the system case is connected to this pin.

Audio Connector: AUDIO

This is an interface for connections to external audio devices.

Pin	Signal
1	LINE IN R
3	LINE IN L
5	LINEOUT_R
7	LINEOUT_L
9	SURROUT R
11	SENSE_A
13	CEN_OUT
15	N/A
17	SPDIF_IN

Pin	Signal
2	AGND
4	+5V
6	MIC IN L
8	MIC IN R
10	SURROUT L
12	SENSE_B
14	LFE_OUT
16	N/A
18	GND

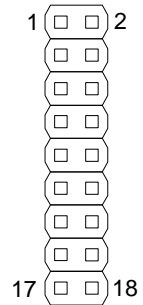

Serial Port Connector: COM Port

COM port pin header can be used to attach additional ports for serial mouse or other serial devices.

Pin	Signal
1	#DCDA
2	RXDA
3	TXDA
4	#DTRA
5	GND

Pin	Signal
6	#DSRA
7	#RTSA
8	#CTSA
9	#RIA
10	NC

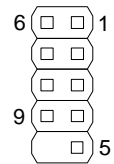

LVDS/DVI Panel Connector: LVDS Panel

The LVDS/DVI Panel connector allows you to connect the panel's LVDS cable directly to support LVDS panel without any need of a daughter card.

Connector: ACES 87216-4016 (2x20 pins / 1.0mm)

Matching Connector: ACES 87219-4000

Pin	Signal	Pin	Signal
1	+12V	2	+LCD1_D0
3	+12V	4	-LCD1_D0
5	-LCD1_D2	6	+3V
7	+LCD1_D2	8	+LCD1_D1
9	+12V	10	-LCD1_D1
11	-LCD2_CLK	12	+3V
13	+LCD2_CLK	14	-LCD1_CLK
15	+5V	16	+LCD1_CLK
17	-LCD2_D3	18	+3V
19	+LCD2_D3	20	-LCD1_D3
21	+5V	22	+LCD1_D3
23	+LCD2_D2	24	GND
25	-LCD2_D2	26	+LCD2_D0
27	GND	28	-LCD2_D0
29	+LCD2_D1	30	GND
31	-LCD2_D1	32	SPD1
33	GND	34	SPCLK1
35	ENAVDD1	36	ENABLT2
37	ENAVDD2	38	ENABLT1
39	GND	40	GND

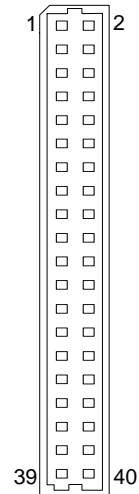

For DVI Connector Signal

Pin	DVI Connector Signal	CN5 Signal
2	TXC+	+LCD1_D0
4	TXC-	-LCD1_D0
5	TX1-	-LCD1_D2
7	TX1+	+LCD1_D2
8	TX0+	+LCD1_D1
10	TX0-	-LCD1_D1
14	TX2-	-LCD1_CLK
16	TX2+	+LCD1_CLK
32	I ² C Data	SPD1
34	I ² C Clock	SPCLK1

For LCD Connector Signal

Pin	LCD Connector Signal	Function	CN5 Signal
11	RxCLK-	-LVDS Receiver Clock Signal	-LCD2_CLK
13	RxCLK+	+LVDS Receiver Clock Signal	+LCD2_CLK
17	Rx3-	-LVDS Receiver Signal	-LCD2_D3
19	Rx3+	+LVDS Receiver Signal	+LCD2_D3
23	Rx2+	+LVDS Receiver Signal	+LCD2_D2
25	Rx2-	-LVDS Receiver Signal	-LCD2_D2
26	Rx0+	+LVDS Receiver Signal	+LCD2_D0
28	Rx0-	-LVDS Receiver Signal	-LCD2_D0
29	Rx1+	+LVDS Receiver Signal	+LCD2_D1
31	Rx1-	-LVDS Receiver Signal	-LCD2_D1

This connector work also as an interface and allows you to connect the EPIA PX's daughter card, PX-O.

For LCD Inverter Control Signal

Pin	PX-O (CN10) Signal	Pin	CN5 Signal
6	SPD1	32	SPD1
7	SPCLK1	34	SPCLK1
8	ENAVDD2	37	ENAVDD2
9	ENABLT2	36	ENABLT2

Multimedia Connector

It is to connect to a multimedia daughter board for more multimedia functions.

Pin	Signal
1	HTVD2
3	+5V
5	+5V
7	HTVD12
9	HTVD14
11	CAPD13
13	CAPD12
15	GND
17	CAPD14
19	TS1ERR
21	CAPD11
23	CAPHS1
25	#PCIRST1
27	CAPD8
29	GND
31	CAPCLK1
33	CAPD1
35	CAPD0
37	CAPD6
39	CAPHS
41	GND
43	SMBDT
45	SMBCK
47	HTVD5
49	HTVD9
51	CAPD3
53	CAPD7
55	CAPCLK
57	CAPD4
59	GND
61	GPIO2
63	CAPD5
65	CAPV3
67	GPIO3
69	#SIOSMI
71	#LDRQ1
73	LAD1
75	SERIRQ
77	GND
79	SIOOSC2

Pin	Signal
2	HTVD8
4	HTVD7
6	HTVD10
8	+5V
10	HTVD6
12	HTVD4
14	HTVCLKR
16	+5V
18	DVP1DET
20	HTVVS
22	HTVD0
24	HTVHS
26	HTVD1
28	HTVD13
30	CAPVS1
32	CAPD9
34	CAPD10
36	CAPD15
38	DVP0DE
40	HTVDE
42	HTVD15
44	HTVD3
46	HTVD11
48	CAPD2
50	GND
52	HTVCLK
54	SPDIF_OUT
56	HTVFLD
58	SPD1
60	SPCLK1
62	DISPCLKO1
64	DISPCLKI1
66	+3V
68	+3V
70	+3V
72	LAD2
74	LAD3
76	#LFRAME
78	LAD0
80	PCLKLPC

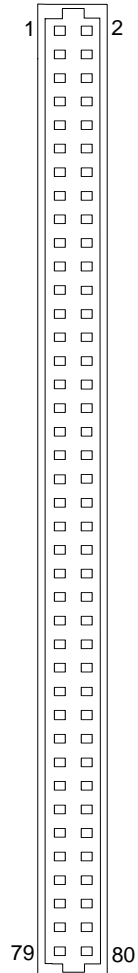

JUMPERS

The mainboard provides jumpers for setting some mainboard functions. This section will explain how to change the settings of the mainboard functions using the jumpers.

Clear CMOS: CMOS Reset

The onboard CMOS RAM stores system configuration data and has an onboard battery power supply. To reset the CMOS settings, set the jumper on pins 2 and 3 while the system is off. Return the jumper to pins 1 and 2 afterwards. Setting the jumper while the system is on will damage the mainboard.

Setting	1	2	3
Normal Operation	ON	ON	OFF
Clear CMOS setting	OFF	ON	ON

Normal: 
1 2 3

Clear: 
1 2 3



Caution:

Except when clearing the RTC RAM, never remove the cap on CMOS Reset jumper default position. Removing the cap will cause system boot failure. Avoid clearing the CMOS while the system is on; it will damage the mainboard.

CHAPTER 3

BIOS Setup

This chapter gives a detailed explanation of the BIOS setup functions.

ENTERING SETUP

Power on the computer and press <Delete> during the beginning of the boot sequence to enter the BIOS setup menu. If you missed the BIOS setup entry point, you may restart the system and try again.

CONTROL KEYS

Keys	Description
Up Arrow	Move to the previous item
Down Arrow	Move to the next item
Left Arrow	Move to the item in the left side
Right Arrow	Move to the item in the right side
Enter	Select the item
Escape	Jumps to the Exit menu or returns to the main menu from a submenu
Page Up / +	Increase the numeric value or make changes
Page Down / -	Decrease the numeric value or make changes
F1	General help, only for Status Page Setup Menu and Option Page Setup Menu
F5	Restore the previous CMOS value from CMOS, only for Option Page Setup Menu
F6	Load the default CMOS value from Fail-Safe default table, only for Option Page Setup Menu
F7	Load Optimized defaults
F9	Jumps to the Main Menu
F10	Save all the CMOS changes and exit

NAVIGATING THE BIOS MENUS

The main menu displays all the BIOS setup categories. Use the Up/Down/Left/Right arrow keys to select any item or sub-menu. Description of the selected/highlighted category is displayed at the bottom of the screen.

An arrow symbol next to a field indicates that a sub-menu is available (see figure below). Press <Enter> to display the sub-menu. To exit the sub-menu, press <Esc>.

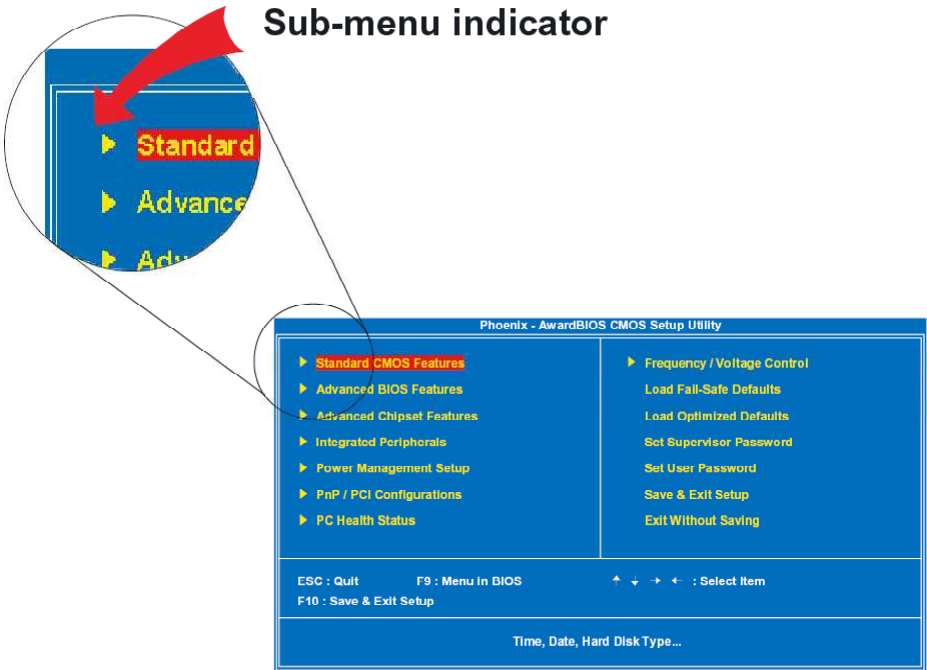

GETTING HELP

The BIOS setup program provides a "General Help" screen. You can display this screen from any menu/sub-menu by pressing <F1>. The help screen displays the keys for using and navigating the BIOS setup. Press <Esc> to exit the help screen.

MAIN MENU

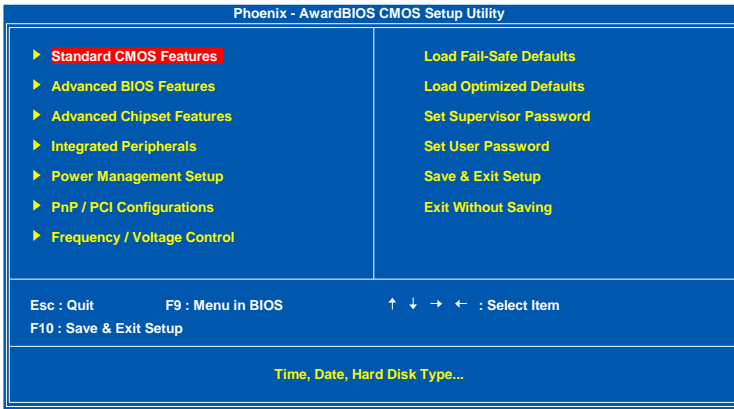

Standard CMOS Features

Use this menu to set basic system configurations.

Advanced BIOS Features

Use this menu to set the advanced features available on your system.

Advanced Chipset Features

Use this menu to set chipset specific features and optimize system performance.

Integrated Peripherals

Use this menu to set onboard peripherals features.

Power Management Setup

Use this menu to set onboard power management functions.

PnP/PCI Configurations

Use this menu to set the PnP and PCI configurations.

Frequency/Voltage Control

Use this menu to set the system frequency and voltage control.

Load Fail-Safe Defaults

Use this menu option to load the BIOS default settings for minimal and stable system operations.

Load Optimized Defaults

Use this menu option to load BIOS default settings for optimal and high performance system operations.

Set Supervisor Password

Use this menu option to set the BIOS supervisor password.

Set User Password

Use this menu option to set the BIOS user password.

Save & Exit Setup

Save BIOS setting changes and exit setup.

Exit Without Saving

Discard all BIOS setting changes and exit setup.

STANDARD CMOS FEATURES

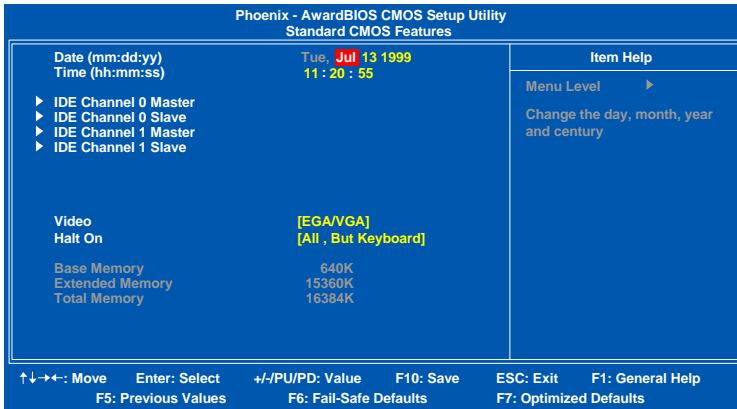

Date

The date format is [Day, Month Date Year]

Time

The time format is [Hour : Minute : Second]

Halt On

Sets the system's response to specific boot errors. Below is a table that details the possible settings.

Setting	Description
All Errors	System halts when any error is detected
No Errors	System does not halt for any error
All, But Keyboard	System halts for all non-key errors

Video

Settings: [EGA/VGA, CGA 40, CGA 80, MONO]

IDE DRIVES

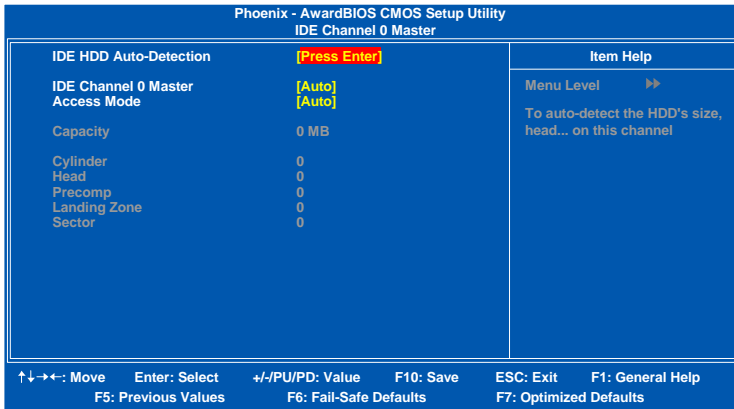

The specifications of your drive must match with the drive table. The hard disk will not work properly if you enter incorrect information in this category. Select “Auto” whenever possible. If you select “Manual”, make sure the information is from your hard disk vendor or system manufacturer. Below is a table that details required hard drive information when using the “Manual” mode.

Setting	Description
IDE Channel	The name of this match the name of the menu. Settings: [None, Auto, Manual]
Access Mode	Settings: [CHS, LBA, Large, Auto]
Capacity	Formatted size of the storage device
Cylinder	Number of cylinders
Head	Number of heads
Precomp	Write precompensation
Landing Zone	Cylinder location of the landing zone
Sector	Number of sectors

ADVANCED BIOS FEATURES

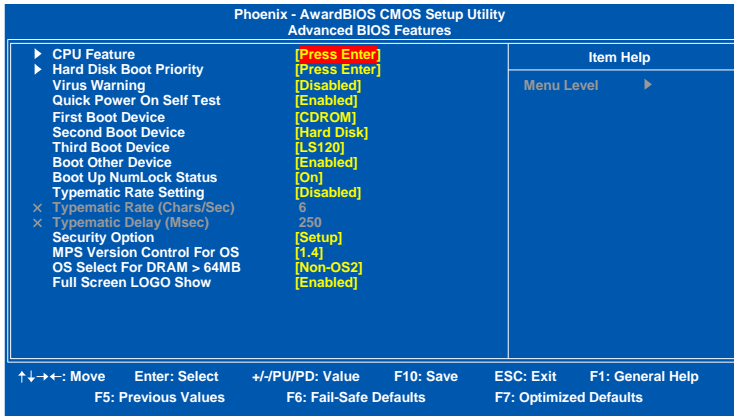

Virus Warning

Setting	Description
Enabled	Turns on hard disk boot sector virus protection
Disabled	Turns off hard disk boot sector virus protection

Quick Power On Self-Test

Shortens Power On Self-Test (POST) cycle to enable shorter boot up time.

Setting	Description
Enabled	Shorten Power On Self Test (POST) cycle and bootup time
Disabled	Standard Power On Self Test (POST)

First/Second/Third Boot Device

Set the boot device sequence as BIOS attempts to load the disk operating system.

Setting	Description
LS120	Boot from LS-120 drive
Hard Disk	Boot from the HDD
CD-ROM	Boot from CD-ROM
ZIP100	Boot from ATAPI ZIP drive
USB-FDD	Boot from USB floppy drive
USB-ZIP	Boot from USB ZIP drive
USB-CDROM	Boot from USB CDROM
Legacy LAN	Boot from network drive
Disabled	Disable the boot device sequence

Boot Other Device

Enables the system to boot from alternate devices if the system fails to boot from the "First/Second/Third Boot Device" list.

Setting	Description
Enabled	Enable alternate boot device
Disabled	No alternate boot device allowed

Boot Up NumLock Status

Set the NumLock status when the system is powered on.

Setting	Description
On	Forces keypad to behave as 10-key
Off	Forces keypad to behave as arrow keys

Typematic Rate Setting

Enables "Typematic Rate" and "Typematic Delay" functions.

Settings: [Enabled, Disabled]

Security Option

Selects whether the password is required every time the System boots, or only when you enter Setup.

Setting	Description
Setup	Password prompt appears only when end users try to run BIOS Setup
System	Password prompt appears every time when the computer is powered on and when end users try to run BIOS Setup

MPS Variation Control for OS

Settings: [1.1, 1.4]

OS Select For DRAM > 64MB

Select OS2 only if you are running OS/2 operating system with greater than 64MB of RAM on the system.

Settings: [Non-OS2, OS2]

Full Screen Logo Show

Show full screen logo during BIOS boot up process.

Settings: [Enabled, Disabled]

CPU FEATURE

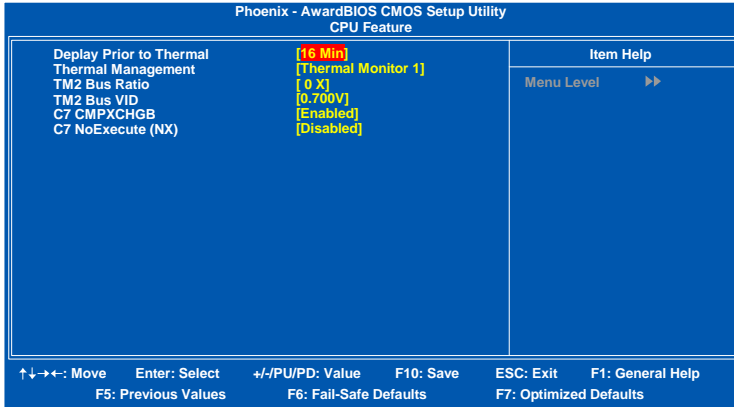

Display Prior to Thermal

Settings: [4 Min, 8 Min, 16 Min, 32 Min]

Thermal Management

This item sets CPU's thermal control rule to protect CPU from overheat.

Setting	Description
Thermal Monitor 1	On-die throttling
Thermal Monitor 2	Ratio & VID transition

TM2 Bus Ratio

This item sets the frequency (bus ratio) of the throttled performance that will be initiated when the on die sensor goes from not hot to hot.

Key in a DEC number.

Settings: [Min = 0, Max = 255]

TM2 Bus VID

This item sets the voltage of the throttled performance that will be initiated when the on die sensor goes from not hot to hot.

Settings: [0.700V, 0.716V, 0.732V, 0.748V, 0.764V, 0.780V, 0.796V, 0.812V, 0.828V, 0.844V, 0.860V, 0.876V, 0.892V, 0.908V, 0.924V, 0.940V, 0.956V, 0.972V, 0.988V, 1.004V, 1.020V, 1.036V, 1.052V, 1.068V, 1.084V, 1.100V, 1.116V, 1.132V, 1.148V, 1.164V, 1.180V, 1.196V, 1.212V, 1.228V, 1.244V, 1.260V, 1.276V, 1.292V, 1.308V, 1.324V, 1.340V, 1.356V, 1.372V, 1.388V, 1.404V, 1.420V, 1.436V, 1.452V, 1.468V, 1.484V, 1.500V, 1.516V, 1.532V, 1.548V, 1.564V, 1.580V, 1.596V, 1.612V, 1.628V, 1.644V, 1.660V, 1.676V, 1.692V, 1.708]

C7 CMPXCHGB

Settings: [Enabled, Disabled]

C7 NoExecute (NX)

Settings: [Enabled, Disabled]

HARD DISK BOOT PRIORITY

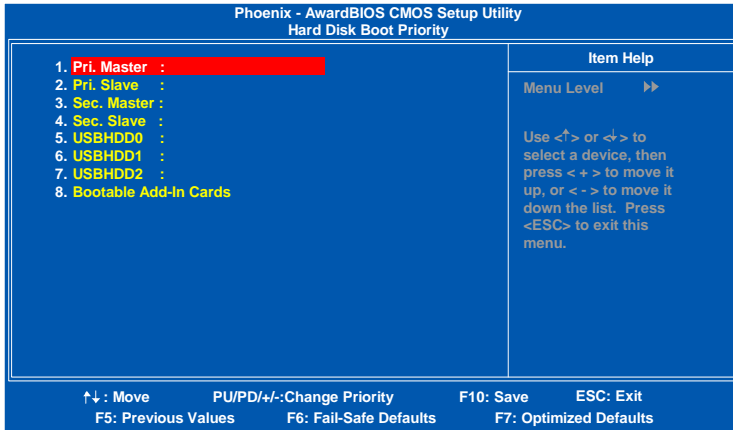

This is for setting the priority of the hard disk boot order when the "Hard Disk" option is selected in the "[First/Second/Third] Boot Device" menu item.

ADVANCED CHIPSET FEATURES

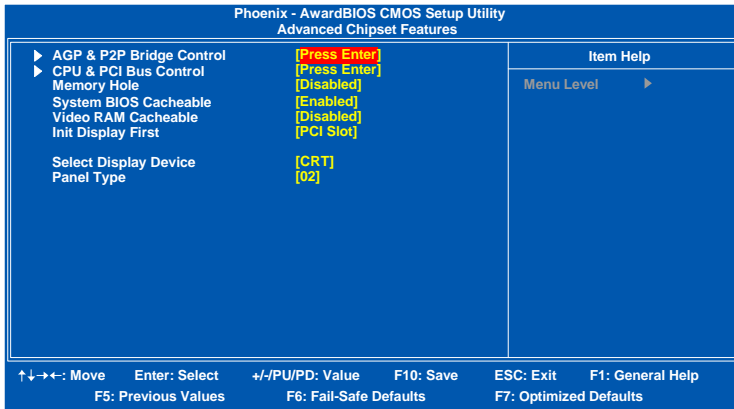

Caution:

The Advanced Chipset Features menu is used for optimizing the chipset functions. Do not change these settings unless you are familiar with the chipset.

Memory Hole

Settings: [Disabled, 15M – 16M]

System BIOS Cacheable

Settings: [Disabled, Enabled]

Video RAM Cacheable

Settings: [Disabled, Enabled]

Init Display First

Settings: [PCI Slot, AGP]

Select Display Device

This setting refers to the type of display being used with the system.

Settings: [CRT, LCD, CRT+LCD, TV, LCD+TV]

Panel Type

This setting refers to the native resolution of the display being used with the system.

Key in a HEX number.

Settings: [Min = 0000, Max = 000F]

AGP & P2P BRIDGE CONTROL

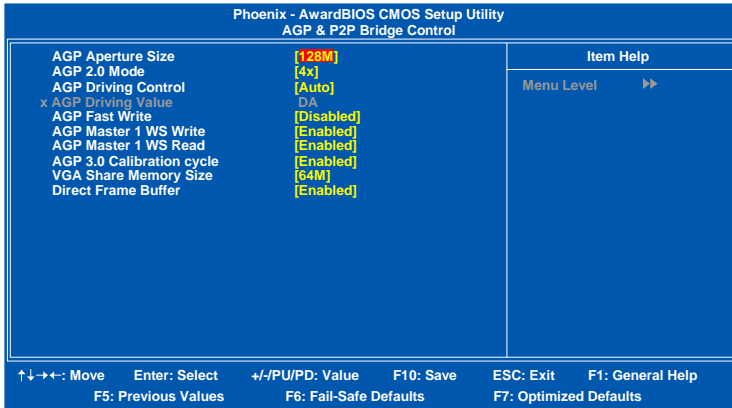

AGP Aperture Size

This setting controls how much memory space can be allocated to AGP for video purposes. The aperture is a portion of the PCI memory address range dedicated to graphics memory address space. Host cycles that hit the aperture range are forwarded to the AGP without any translation.

Settings: [32MB, 64MB, 128MB, 256MB, 512MB, 1G]

AGP 2.0 Mode

This mainboard supports the AGP 4x interface. When the AGP 4x video card is used, it can transfer video data at 1066MB/s. AGP 4x is backward compatible, leave the default 4x mode on. AGP 4x mode can be detected automatically once you plug in the AGP 4x card.

Settings: [4x, 2x, 1x]

AGP Driving Control

This item is used to signal driving current on AGP cards to auto or manual.

Settings: [Auto, Manual]

AGP Fast Write

This item is used to enable or disable the caching of display data for the video memory of the processor.

Settings: [Enabled, Disabled]

AGP Master 1 WS Write

Settings: [Enabled, Disabled]

AGP Master 1 WS Read

Settings: [Enabled, Disabled]

AGP 3.0 Calibration Cycle

Settings: [Enabled, Disabled]

VGA Share Memory Size

Settings: [Disabled, 32M, 64M, 128M]

Direct Frame Buffer

Settings: [Enabled, Disabled]

CPU & PCI BUS CONTROL

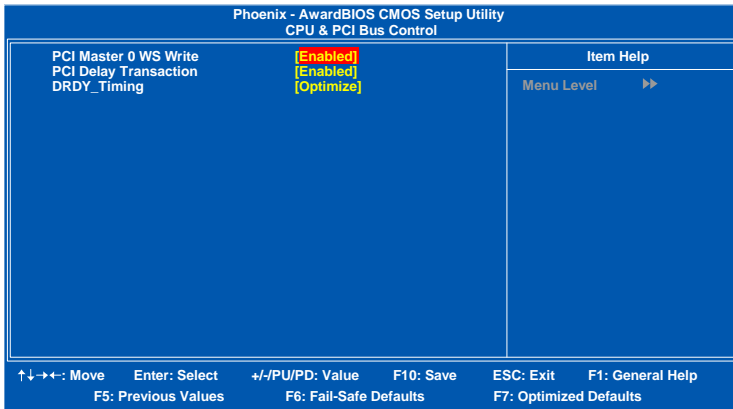

PCI Master 0 WS Write

Settings: [Enabled, Disabled]

PCI Delay Transaction

Settings: [Enabled, Disabled]

DRDY_Timing

Settings: [Slowest, Default, Optimize]

INTEGRATED PERIPHERALS

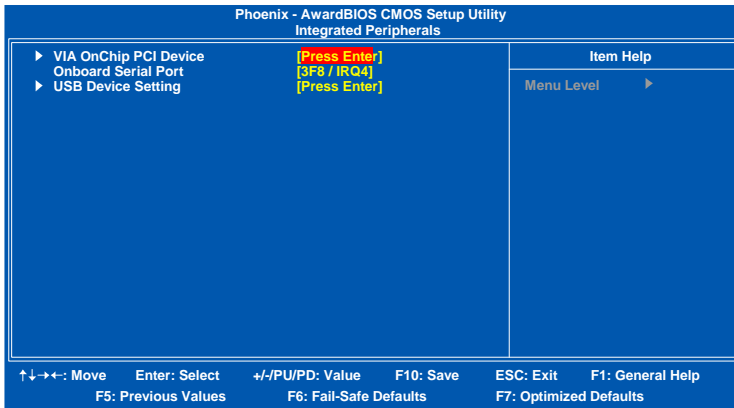

Onboard Serial Port

Settings: [Disabled, 3F8/IRQ4, 2F8/IRQ3, 3E8/IRQ4, 2E8/IRQ3, Auto]

VIA ONCHIP PCI DEVICE

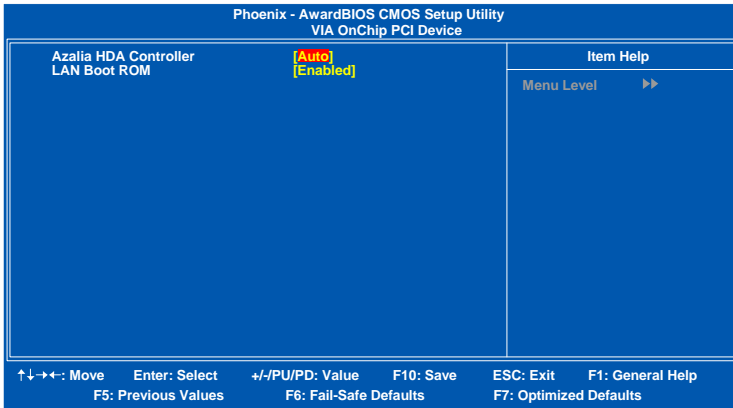

Azalia HDA Controller

Settings: [Auto, Disabled]

LAN Boot ROM

Settings: [Enabled, Disabled]

USB DEVICE SETTING

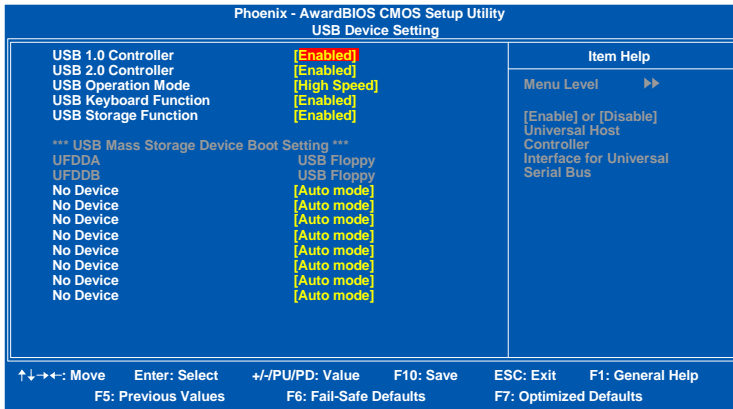

USB 1.0 Controller

Enable or disable Universal Host Controller Interface for Universal Serial Bus.

Settings: [Enabled, Disabled]

USB 2.0 Controller

Enable or disable Enhanced Host Controller Interface for Universal Serial Bus.

Settings: [Enabled, Disabled]

USB Operation Mode

Auto decide USB device operation mode.

Setting	Description
High Speed	If USB device was high speed device, then it operated on high speed mode. If USB device was full/low speed device, then it operated on full/low speed mode.
Full/Low Speed	All of USB Device operated on full/low speed mode

USB Keyboard Function

Enable or disable Legacy support of USB Keyboard

Settings: [Enabled, Disabled]

USB Storage Function

Enable or disable Legacy support of USB Mass Storage

Settings: [Enabled, Disabled]

No Device

Setting	Description
Auto mode	According to contents of USB MSD decide boot up type.
FDD mode	The USB MSD always boot up as floppy disk.
HDD mode	The USB MSD always boot up as hard disc.

POWER MANAGEMENT SETUP

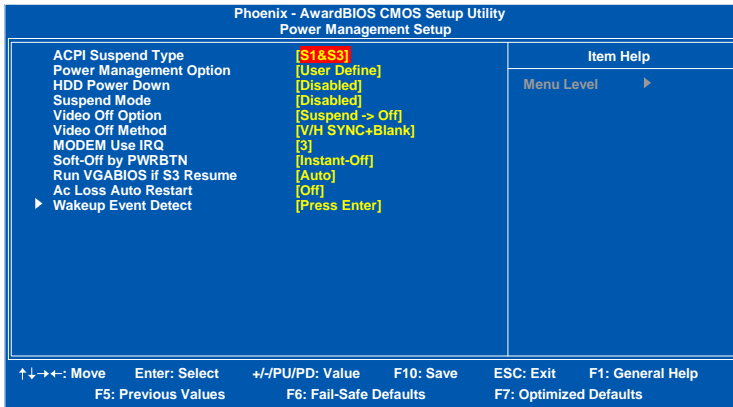

ACPI Suspend Type

Setting	Description
S1(POS)	S1/Power On Suspend (POS) is a low power state. In this state, no system context (CPU or chipset) is lost and hardware maintains all system contexts.
S3(STR)	S3/Suspend To RAM (STR) is a power-down state. In this state, power is supplied only to essential components such as main memory and wakeup-capable devices. The system context is saved to main memory, and context is restored from the memory when a "wakeup" event occurs.
S1 & S3	Depends on the OS to select S1 or S3.



Note:

Only supports S/W S3 mode.

Power Management Option

Settings: [User Define, Min Saving, Max Saving]

HDD Power Down

Sets the length of time for a period of inactivity before powering down the hard disk.

Settings: [Disabled, 1~15(minutes)]

Suspend Mode

Settings: [Disabled, 1 Min, 2 Min, 4 Min, 6 Min, 8 Min, 10 Min, 20 Min, 30 Min, 40 Min, 1 Hour]

Video Off Option

Select whether or not to turn off the screen when system enters power saving mode, ACPI OS such as Windows XP will override this option.

Setting	Description
Always On	Screen is always on even when system enters power saving mode
Suspend -> Off	Screen is turned off when system enters power saving mode

Video Off Method

Settings: [Blank Screen, V/H SYNC+Blank, DPMS Support]

MODEM Use IRQ

Settings: [NA, 3, 4, 5, 7, 9, 10, 11]

Soft-Off by PWRBTN

Setting	Description
Delay 4 Sec	System is turned off if power button is pressed for more than four seconds
Instant-Off	Power button functions as a normal power-on/-off button

Run VGABIOS if S3 Resume

Select whether to run VGA BIOS if resuming from S3 state. This is only necessary for older VGA drivers.

Settings: [Auto, Yes, No]

AC Loss Auto restart

The field defines how the system will respond after an AC power loss during system operation.

Setting	Description
Off	Keeps the system in an off state until the power button is pressed
On	Restarts the system when the power is back
Former-Sts	Former-Sts

WAKEUP EVENT DETECT

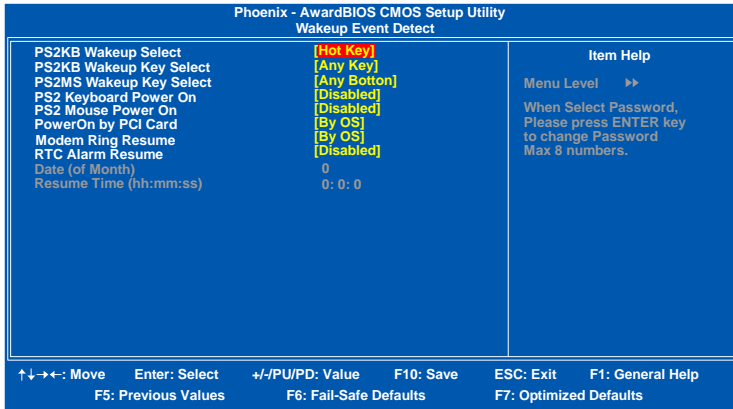

PS2KB Wakeup Select

When selecting Password, press Enter to change password. The maximum number of characters is eight.

Settings: [Hot Key, Password]

PS2KB Wakeup Key Select

Sets a Hot Key to restore the system from the power saving mode to an active state.

Settings: [Ctrl+F1, Ctrl+F2, Ctrl+F3, Ctrl+F4, Ctrl+F5, Ctrl+F6, Ctrl+F7, Ctrl+F8, Ctrl+F9, Ctrl+F10, Ctrl+F11, Ctrl+F12, Power, Wake, Any Key]

PS2MS Wakeup Key Select

Enables any mouse activity to restore the system from the power saving mode to an active state.

Settings: [Any Button, Left Button, Right Button]

PS2 Keyboard Power On

Settings: [Disabled, Enabled]

PS2 Mouse Power On

Settings: [Disabled, Enabled]

PowerOn by PCI Card

Enables activity detected from any PCI card to power up the system or resume from a suspended state. Such PCI cards include LAN, onboard USB ports, etc.

Settings: [By OS, Enabled]

Modem Ring Resume

Settings: [By OS, Enabled]

RTC Alarm Resume

Sets a scheduled time and/or date to automatically power on the system.

Settings: [Disabled, Enabled]

Date (of Month)

The field specifies the date for "RTC Alarm Resume".

Resume Time (hh:mm:ss)

The field specifies the time for "RTC Alarm Resume".

PNP/PCI CONFIGURATIONS

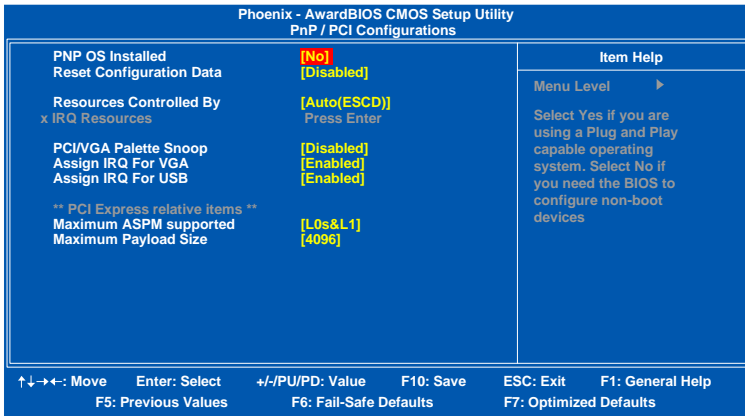

Note:
This section covers some very technical items and it is strongly recommended to leave the default settings as is unless you are an experienced user.

PNP OS Installed

Setting	Description
Yes	BIOS will only initialize the PnP cards used for booting (VGA, IDE, SCSI). The rest of the cards will be initialized by the PnP operating system
No	BIOS will initialize all the PnP cards

Reset Configuration Data

This field should usually be left "Disabled".

Setting	Description
Enabled	Resets the ESCD (Extended System Configuration Data) after exiting BIOS Setup if a newly installed PCI card or the system configuration prevents the operating system from loading
Disabled	Default setting

Resource Controlled By

Enables the BIOS to automatically configure all the Plug-and-Play compatible devices.

Setting	Description
Auto(ESCD)	BIOS will automatically assign IRQ, DMA and memory base address fields
Manual	Unlocks "IRQ Resources" for manual configuration

PCI/VGA Palette Snoop

Settings: [Disabled, Enabled]

Assign IRQ For VGA/USB

Assign IRQ for VGA and USB devices.

Settings: [Disabled, Enabled]

Maximum ASPM supported

Control maximum level of ASPM supported on the given PCI Express links on the system.

Settings: [L0, L0s, L1, L0s&L1]

Maximum Payload Size

Set maximum TLP payload size for the PCI Express devices. The unit is byte.

Settings: [128, 256, 512, 1024, 2048, 4096]

FREQUENCY / VOLTAGE CONTROL

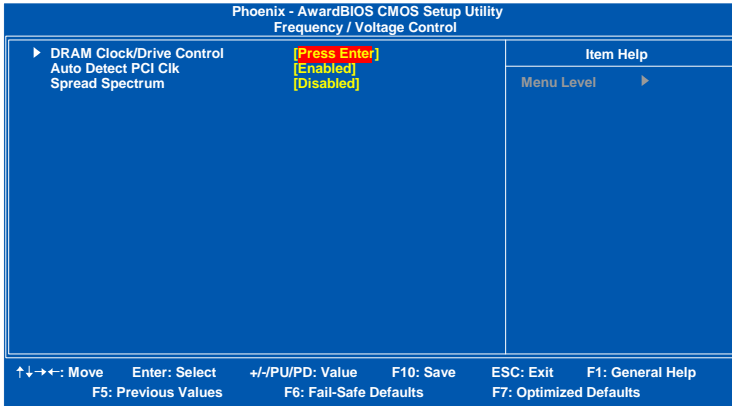

Auto Detect PCI Clk

Settings: [Disabled, Enabled]

Spread Spectrum

When the mainboard's clock generator pulses, the extreme values (spikes) of the pulses create EMI (Electromagnetic Interference). The Spread Spectrum function reduces the EMI generated by modulating the pulses so that the spikes of the pulses are reduced to flatter curves.

Settings: [Disabled, 0.20%, 0.25%, 0.35%]

DRAM CLOCK/DRIVE CONTROL

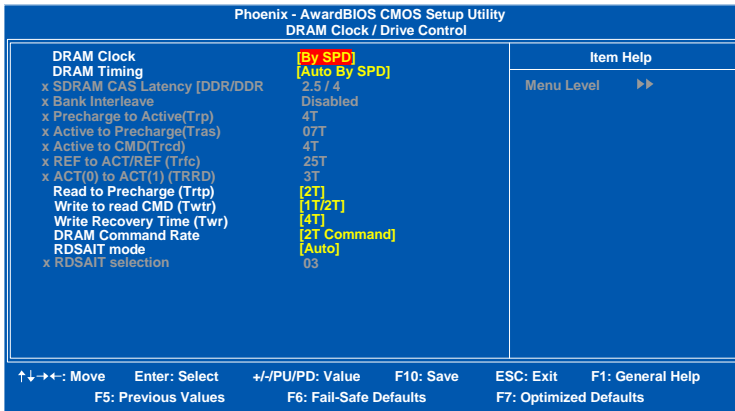

DRAM Clock

The chipset supports synchronous and asynchronous mode between host clock and DRAM clock frequency.

Settings: [By SPD, 100 MHz, 133 MHz, 166 MHz, 200MHz, 266MHz, 333MHz]

DRAM Timing

The value in this field depends on the memory modules installed in your system. Changing the value from the factory setting is not recommended unless you install new memory that has a different performance rating than the original modules.

Settings: [Manual, Auto By SPD]

Read to Precharge (Trtp)

Settings: [2T, 3T]

Write to Read CMD (Twtr)

Settings: [1T/2T, 2T/3T]

Write Recovery Time (Twr)

Settings: [2T, 3T, 4T, 5T]

DRAM Command Rate

Settings: [2T Command, 1T Command]

RDSAIT mode

Settings: [Manual, Auto]

LOAD FAIL-SAFE DEFAULTS

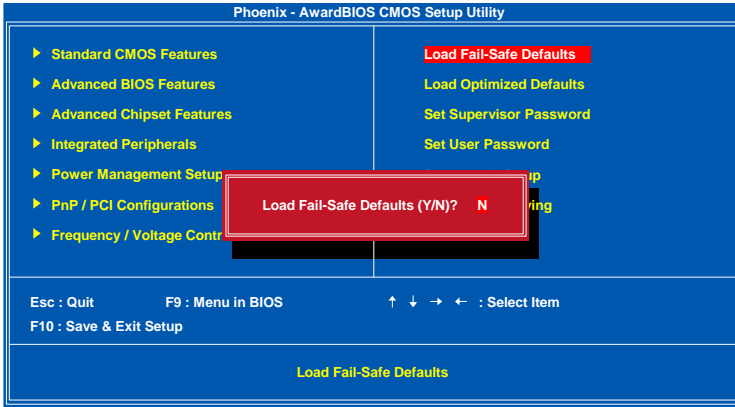

This option is for restoring all the default fail-safe BIOS settings. These values are set by the mainboard manufacturer to provide a stable system with basic performance.

Entering "Y" loads the default fail-safe BIOS values.

LOAD OPTIMIZED DEFAULTS

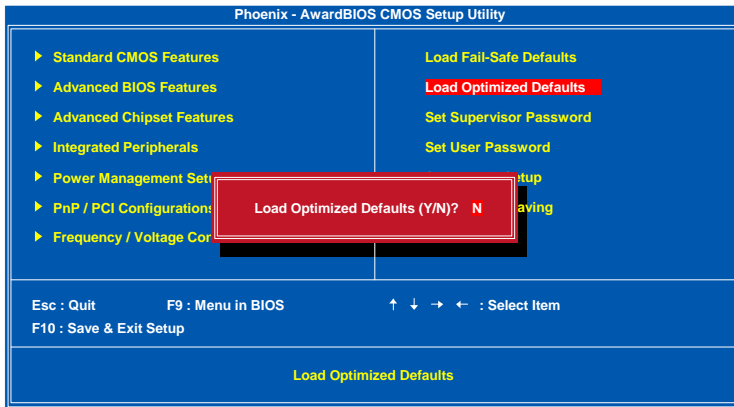

This option is for restoring all the default optimized BIOS settings. The default optimized values are set by the mainboard manufacturer to provide a stable system with optimized performance.

Entering "Y" loads the default optimized BIOS values.

SET SUPERVISOR / USER PASSWORD

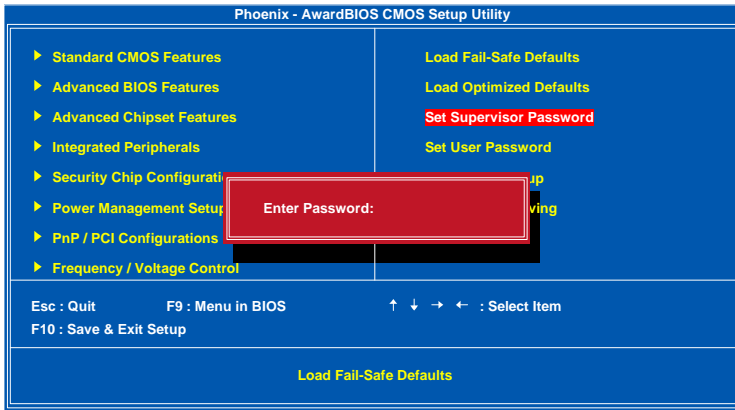

This option is for setting a password for entering BIOS Setup. When a password has been set, a password prompt will be displayed whenever BIOS Setup is run. This prevents an unauthorized person from changing any part of your system configuration.

There are two types of passwords you can set. A supervisor password and a user password. When a supervisor password is used, the BIOS Setup program can be accessed and the BIOS settings can be changed. When a user password is used, the BIOS Setup program can be accessed but the BIOS settings cannot be changed.

To set the password, type the password (up to eight characters in length) and press <Enter>. The password typed now will clear any previously set password from CMOS memory. The new password will need to be reentered to be confirmed. To cancel the process press <Esc>.

To disable the password, press <Enter> when prompted to enter a new password. A message will show up to confirm disabling the password. To cancel the process press <Esc>.

Additionally, when a password is enabled, the BIOS can be set to request the password each time the system is booted. This would prevent unauthorized use of the system. See "Security Option" in the "Advanced BIOS Features" section for more details.

SAVE & EXIT SETUP

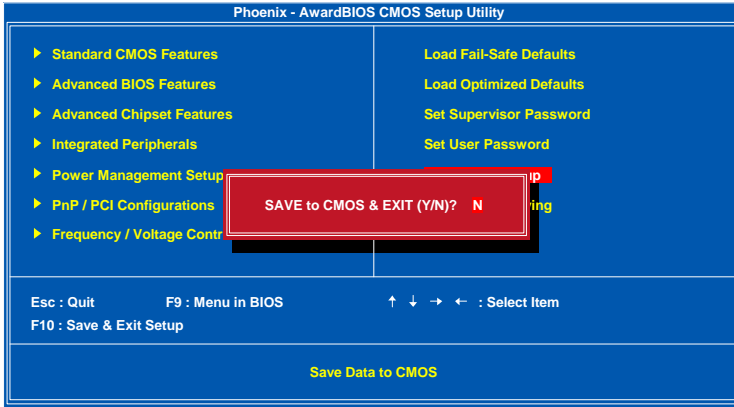

Entering "Y" saves any changes made and exits the program.

Entering "N" will cancel the exit request.

EXIT WITHOUT SAVING

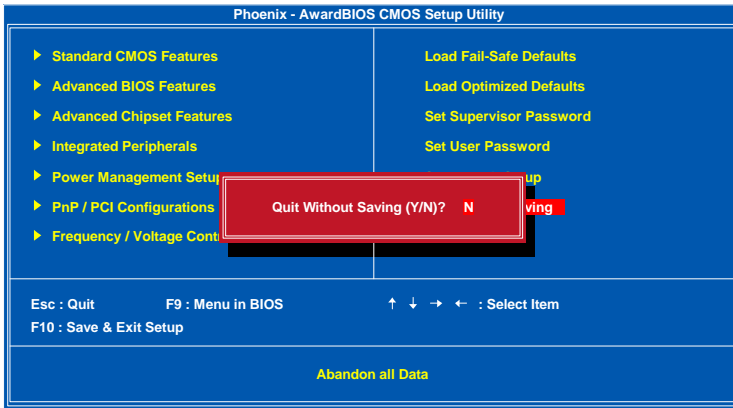

Entering "Y" discards any changes made and exits the program.

Entering "N" will cancel the exit request.

This page is intentionally left blank.

CHAPTER 4

Driver Installation

This chapter gives you brief descriptions of each mainboard driver and application. You must install the VIA chipset drivers first before installing other drivers such as audio or VGA drivers. The applications will only function correctly if the necessary drivers are already installed.

DRIVER UTILITIES

Getting Started

The mainboard includes a Driver Utilities CD that contains the driver utilities and software for enhancing the performance of the mainboard. If the CD is missing from the retail box, please contact the local dealer for the CD.



Note:

The driver utilities and software are updated from time to time. The latest updated versions are available at <http://www.viaembedded.com/>

Running the Driver Utilities CD

To start using the CD, insert the CD into the CD-ROM or DVD-ROM drive. The CD should run automatically after closing the CD-ROM or DVD-ROM drive. The driver utilities and software menu screen should then appear on the screen. If the CD does not run automatically, click on the "Start" button and select "Run..." Then type: "D:\Setup.exe".

**Note:**

D: might not be the drive letter of the CD-ROM/DVD-ROM in your system.

ONTENT

VIA 4in1 Drivers: Contains VIA ATAPI Vendor Support Driver (enables the performance enhancing bus mastering functions on ATA-capable Hard Disk Drives and ensures IDE device compatibility), AGP VxD Driver (provides service routines to your VGA driver and interface directly to hardware, providing fast graphical access), IRQ Routing Miniport Driver (sets the system's PCI IRQ routing sequence) and VIA INF Driver (enables the VIA Power Management function).

- VIA Graphics Driver:** Enhances the onboard VIA graphic chip.
- VIA Audio Driver:** Enhances the onboard VIA audio chip.
- VIA USB 2.0 Driver:** Enhances VIA USB 2.0 ports.
- VIA LAN Driver:** Enhances the onboard VIA 10/100M LAN chip.
- VIA RAID Driver:** Support for SATA RAID devices.