

# VAB-600-D

Daughter board for VAB-600 Pico-ITX mainboard

## Quick Guide

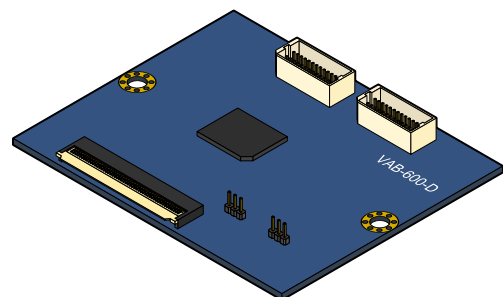

### Key Features:

- Allows LVDS displays supported by VAB-600 mainboard
- Quick installation and easy setup

The VAB-600-D is a daughter board specially designed for VAB-600 Pico-ITX mainboard. By connecting the VAB-600-D to the VAB-600 mainboard, LVDS displays can be fully supported. The VAB-600-D is equipped with two 24-pins LVDS connectors.

### Specifications:

- **PCB Size:**
  - 56 mm x 40 mm (L x W)
  - 4-Layer
- **Onboard Connectors:**
  - 1 x DVO connector
  - 2 x LVDS connectors
- **Onboard Jumpers:**
  - 1 x LVDS power select jumper
  - 1 x LVDS backlight select jumper

### Package Lists:

- 1 x VAB-600-D daughter board
- 1 x DVO flex cable



#### Note:

Please ensure that all items in the packing list are present before using this product. If any of the items are missing or damaged, contact your distributor or sales representative immediately.

## Layout Diagram

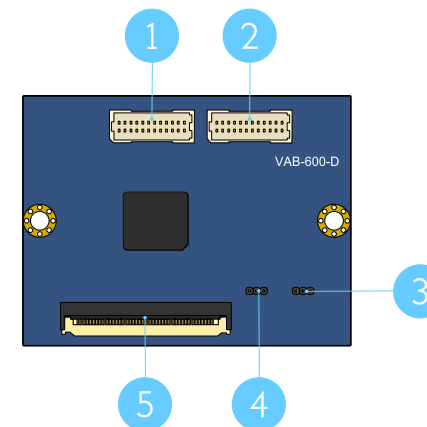

Items	Description
1	LVDS1: LVDS panel connector 1
2	LVDS2: LVDS panel connector 2
3	JM2: LVDS panel backlight select
4	JM1: LVDS panel power select
5	CN1: DVO signal connector

## Dimensions

### Top View

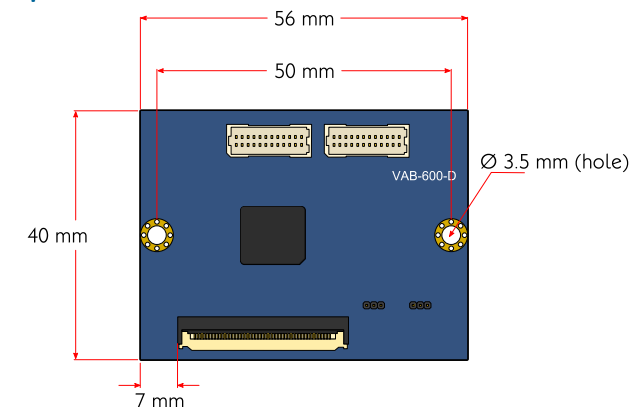

### Side View

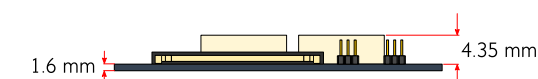

## 1 Installing VAB-600-D to VAB-600 mainboard

### Step 1

Install the VAB-600-D daughter board to a suitable surface and secure it with two screws.

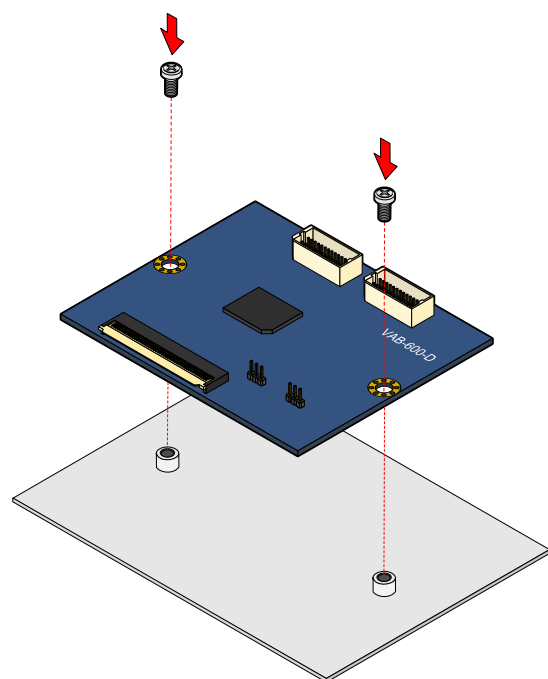

### Step 2

Connect one end of the DVO flex cable to the DVO connector (CN1) on VAB-600-D daughter board and the other end to DVO connector (CN1) on VAB-600 mainboard.

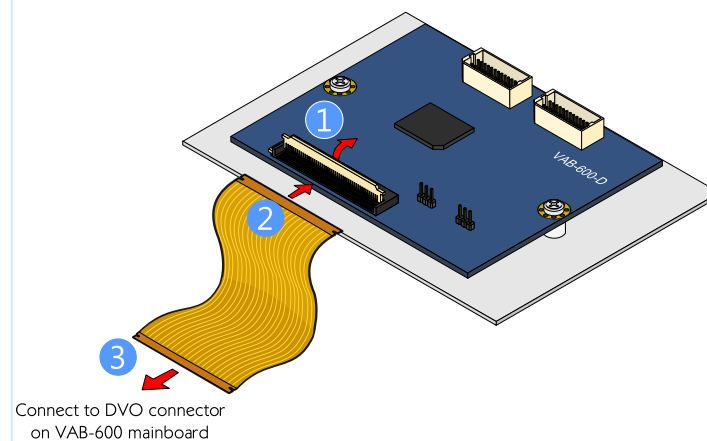

### Step 3

Connect the LVDS display cable connectors to LVDS onboard connectors (LVDS1 and LVDS2).

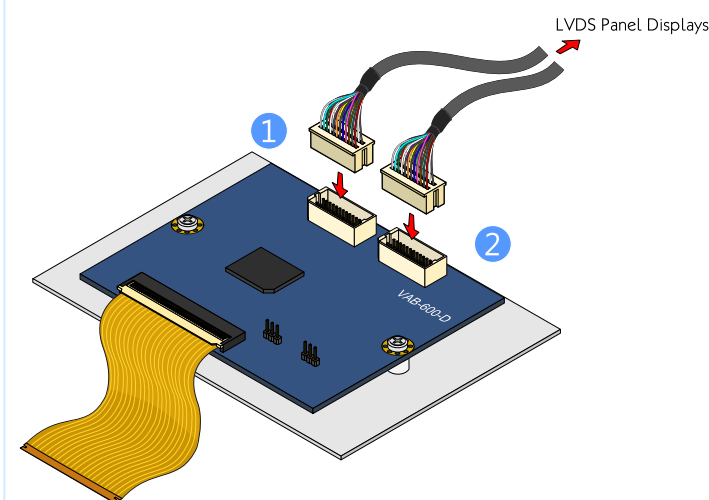

## 2 Select Jumper Settings

### JM1: LVDS Panel Power Select

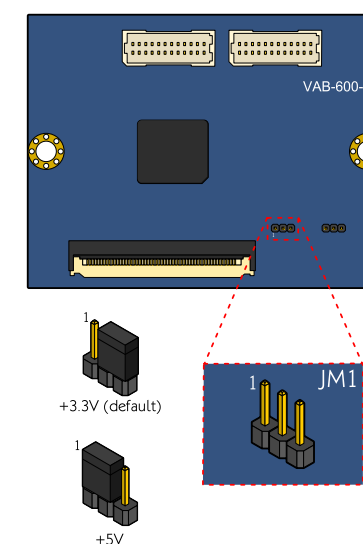

Settings	Pin 1	Pin 2	Pin 3
+3.3V (default)	Off	On	On
+5V	On	On	Off

## JM2: LVDS Panel Backlight Select

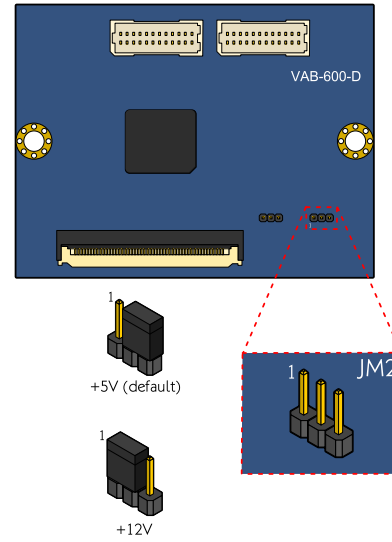

Settings	Pin 1	Pin 2	Pin 3
+5V (default)	Off	On	On
+12V	On	On	Off

# 3

## Connector Pinouts

### CN1: DVO signal connector

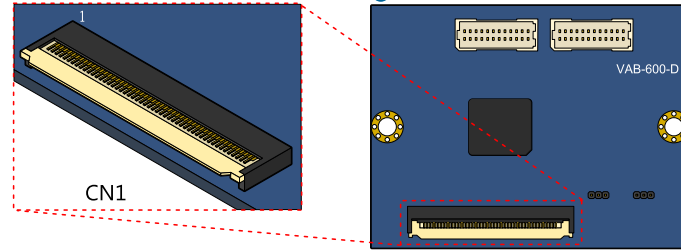

Pin	Signal	Pin	Signal	Pin	Signal
1	GND	18	LD21	35	LD06
2	LVDSENVDD	19	LD20	36	LD05
3	LVDSENBL	20	LD19	37	LD04
4	DVO_DATA	21	LD18	38	LD03
5	DVO_CLK	22	LD17	39	LD02
6	I2C0SDA	23	LD16	40	LD01
7	I2C0SCL	24	GND	41	LD00
8	TTL_RST-	25	LD15	42	GND
9	PWMOUT0	26	LD14	43	VIN (+12V)
10	DVPDE	27	LD13	44	VIN (+12V)
11	DVPVS	28	LD12	45	5VIN
12	DVPHS	29	LD11	46	5VIN
13	GND	30	LD10	47	5VIN
14	DVP1CLK+	31	LD09	48	VCC33
15	GND	32	LD08	49	VCC33
16	LD23	33	GND	50	VCC33
17	LD22	34	LD07		

## LVDS1: LVDS Panel Connector 1

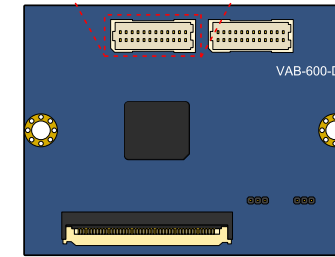
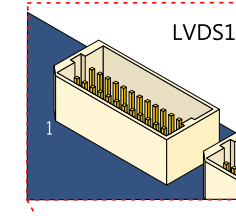

Pin	Signal	Pin	Signal
1	LVDS1_DO0-	2	LCD1_CLK
3	LVDS1_DO0+	4	LCD1_DATA
5	GND	6	PVDD1
7	LVDS1_DO1-	8	PVDD1
9	LVDS1_DO1+	10	VDD_BL
11	GND	12	VDD_BL
13	LVDS1_DO2-	14	DIMMING
15	LVDS1_DO2+	16	LVDS0_RD
17	GND	18	LCD_EN
19	LVDS1_CLK-	20	GND
21	LVDS1_CLK+	22	LVDS1_DO3-
23	GND	24	LVDS1_DO3+

## LVDS2: LVDS Panel Connector 2

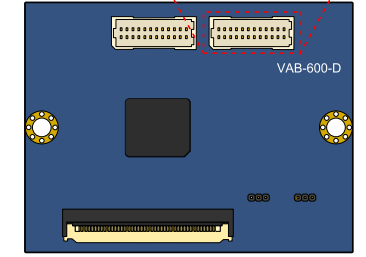
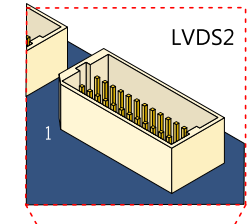

Pin	Signal	Pin	Signal
1	LVDS2_DO0-	2	NA
3	LVDS2_DO0+	4	NA
5	GND	6	PVDD1
7	LVDS2_DO1-	8	PVDD1
9	LVDS2_DO1+	10	VDD_BL
11	GND	12	VDD_BL
13	LVDS2_DO2-	14	NA
15	LVDS2_DO2+	16	EDID_PWR
17	GND	18	NA
19	LVDS2_CLK-	20	GND
21	LVDS2_CLK+	22	LVDS2_DO3-
23	GND	24	LVDS2_DO3+



### Caution:

Please DO NOT plug/unplug LVDS cable to/from LVDS connector when system is powered-ON or running.

### VIA Technologies, Inc.

1F, 531, Zhong-zheng Road,  
Xindian District, New Taipei City 231,  
Taiwan

Tel: 886-2-2218-5452

Fax: 886-2-2218-5453

Web: [www.via.com.tw](http://www.via.com.tw)

For more information on this and  
other VIA products, please visit  
[www.viaembedded.com/en/](http://www.viaembedded.com/en/)

For further support and service,  
please visit [www.via.com.tw](http://www.via.com.tw)